

A TECHNICAL REFERENCE SERIES BROUGHT TO YOU BY OMEGA VOL. 2

TRANSACTIONS

IN MEASUREMENT AND CONTROL

VOLUME 2
DATA ACQUISITION





<http://www.omega.com> • e-mail: das@omega.com

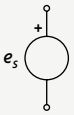

omega.com

Ω OMEGA

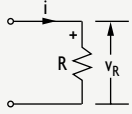
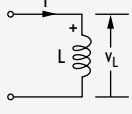
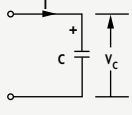
SYMBOLS FOR SIMPLE ELECTRICAL CIRCUITS

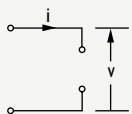
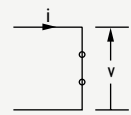
Voltage Source		e_s appears in the circuit for i
Current Source		i_s supplied to the circuit for all v
Resistor		$v_R = iR$
Inductor		$v_L = L \frac{di}{dt}$ or $i = \int v_L dt$
Capacitor		$v_C = \int \frac{1}{C} i dt$ or $i = C \frac{dv_C}{dt}$
Joined Wires		Connection is made at the dot
Unjoined Wires		Wires cross without contact
Open Circuit		i is zero for all v
Short Circuit		v is zero for all i

DECIMAL FACTOR PREFIXES

FACTOR	PREFIX	SYMBOL	FACTOR	PREFIX	SYMBOL
10^{18}	exa	E	10^{-1}	deci	d
10^{15}	peta	P	10^{-2}	centi	c
10^{12}	tera	T	10^{-3}	milli	m
10^9	giga	G	10^{-6}	micro	μ
10^6	mega	M	10^{-9}	nano	n
10^3	kilo	k	10^{-12}	pico	p
10^2	hecto	h	10^{-15}	femto	f
10^1	deka	da	10^{-18}	atto	a

RESISTOR COLOR CODES

COLOR	VALUE OF		
	(1st & 2nd bands)	(3rd band)	(4th band)
Black	0	0	$\pm 20\%$
Brown	1	1	$\pm 2\%$
Red	2	2	
Orange	3	3	
Yellow	4	4	
Green	5	5	
Blue	6	6	
Violet	7	7	
Gray	8	8	
White	9	9	
Gold		-1	$\pm 5\%$
Silver		-2	$\pm 10\%$
No Color			$\pm 20\%$

resistor value = (1st band) × (2nd band) × (10^{3rd band})

resistor tolerance = 4th band (if specified)

STANDARD RESISTOR VALUES

1.0	1.1	1.2	1.3	1.5	1.6
1.8	2.0	2.2	2.4	2.7	3.0
3.3	3.6	3.9	4.3	4.7	5.1
5.6	6.2	6.8	7.5	8.2	9.1

ACRONYMS AT A GLANCE

A: ampere (amp)	HMI: Human-machine interface
ac: alternating current	hz: hertz
A/D: analog-to-digital	I/O: input/output
ADC: analog-to-digital converter	i: current
ANSI: American National Standards Institute	IEEE: Institute of Electrical and Electronic Engineers
ASCII: American Standard Code for Information Interchange	JTFA: joint time-frequency analysis
ASIC: application-specific integrated circuit	L: inductance
b: bit	LED: light emitting diode
B: byte	LSB: least significant bit
bps: bits per second	MAC: media access control
C: capacitance	MFLOPS: million floating-point operations per second
CAN: Controller Area Network	MIPS: million instructions per second
CJC: cold junction compensation	MMI: man-machine interface
CMRR: common-mode rejection ratio	MUX: multiplexer
COM: Component Object Model	ODVA: Open DeviceNet Vendors Association
CPU: central processing unit	OLE: Object Linking and Embedding
CSMA/CD: carrier sense multiple access with collision detection	OSI: Open Systems Interconnect
D/A: digital-to-analog	PC: personal computer
DAC: digital-to-analog converter	PCI: Peripheral Component Interconnect
DAQ: data acquisition	PCMCIA: Personal Computer Memory Card International Association
DAS: data acquisition system	PGA: programmable gain amplifier
dB: decibel	PID: proportional-integral-derivative
dc: direct current	PLC: programmable logic controller
DCE: data communications equipment	R: resistance
DCOM: Distributed Component Object Model	RFI: radio frequency interference
DCS: distributed control system	RMS: root-mean-square
DDE: Dynamic Data Exchange	ROM: read-only memory
DIO: digital input/output	RTD: resistance temperature detector
DLL: Dynamic Link Library	SCADA: supervisory control and data acquisition
DMA: direct memory access	SE: single-ended
DSP: digital signal processing	S/H: sample-and-hold
DTE: data terminal equipment	SNR: signal-to-noise ratio
EEPROM: electrically erasable programmable ROM	SPC: statistical process control
EMF: electromotive force	SQL: Structured Query Language
EMI: electromagnetic interference	SS: simultaneous sampling
EPROM: erasable programmable ROM	STP: shielded twisted pair
FIFO: first-in first-out	TCP/IP: Transmission Control Protocol/Internet Protocol
GPIB: General Purpose Interface Bus	TTL: transistor-to-transistor logic
GUI: graphical user interface	UTP: unshielded twisted pair
	V: volt



©1998 Putman Publishing Company and OMEGA Press LLC.

TRANSACTIONS

I N M E A S U R E M E N T A N D C O N T R O L

Data Acquisition

A Technical Reference Series Brought to You by OMEGA

VOLUME

2

TRANSACTIONS

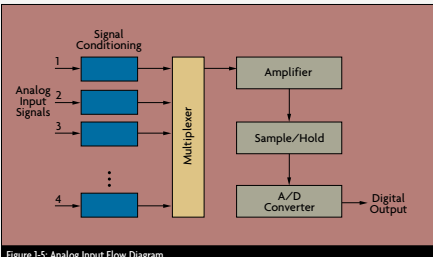
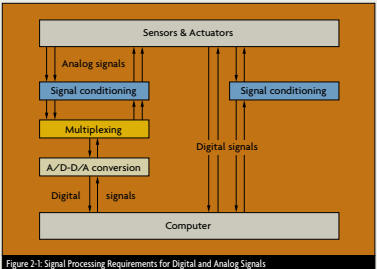
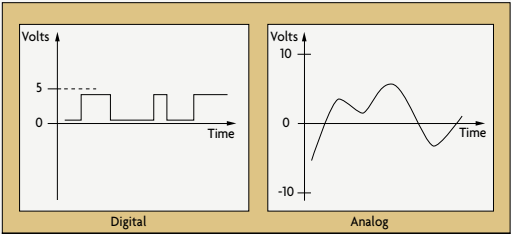
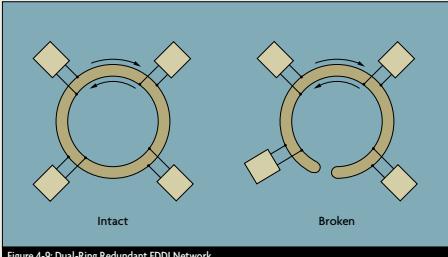

IN MEASUREMENT AND CONTROL

VOLUME 2—DATA ACQUISITION

Section	Topics Covered	Page
1 Analog I/O Functionality	<ul style="list-style-type: none"> • Resolution & Aliasing • Analog-to-Digital • Digital-to-Analog  <p>Figure 1-5: Analog Input Flow Diagram</p>	10
1 Digital I/O Functionality	<ul style="list-style-type: none"> • Digital Inputs • Digital Outputs • Pulse I/O  <p>Figure 2-1: Signal Processing Requirements for Digital and Analog Signals</p>	17
3 Analog Signal Transmission	<ul style="list-style-type: none"> • Analog Signal Types • Noise & Grounding • Wire & Cable Options  <p>Figure 3-2: Digital and Analog Signal Representations</p>	19
4 Digital Signal Transmission	<ul style="list-style-type: none"> • The OSI Network Model • Physical Layer Options • Network Topologies • Fieldbus & Device Networks  <p>Figure 4-9: Dual-Ring Redundant FDDI Network</p>	24

REFERENCE SECTIONS

Inside Front Cover	02	68	Information Resources
Table of Contents	06	72	Glossary
Editorial	08	79	Index
About OMEGA	09	82	List of Figures

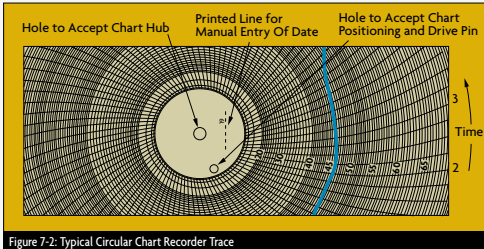
Section	Topics Covered	Page	
5 Data Acquisition Hardware	<ul style="list-style-type: none"> • Selecting a System • Plug-in-Cards • Standalone Components • Communication Devices 		36
6 Presentation & Analysis	<ul style="list-style-type: none"> • Development Considerations • Component Architectures • Off-the-Shelf Offerings 		48
7 Recording, Printing & Storage	<ul style="list-style-type: none"> • Definitions and Classifications • Trend Recorders • Data Loggers • Videographic Recorders 	 <p style="font-size: small;">Figure 7-2: Typical Circular Chart Recorder Trace</p>	58

A Commitment to Standards

Since OMEGA first opened its doors back in 1962, the practice of data acquisition has changed at least as much as OMEGA itself.

At that time, OMEGA offered a single line of fine-gauge thermocouples; now our scientific and industrial measurement and control products number more than 68,000. In 1962, scientific and industrial data acquisition systems—if they could be called systems at all—consisted primarily of data manually logged by technicians on clipboards and reams of analog recorder paper. And while many recorders still do record on paper, the now ubiquitous microprocessor has revolutionized pretty much everything else.

The PC and other microprocessor-based devices have replaced analog recording and display technologies in all but the simplest data acquisition applications. And while computers have had an undeniably positive impact on the practice of data acquisition, they have also added unprecedented levels of complexity.

Analog-to-digital conversion and other signal conditioning functions come in a myriad of form factors. Networked devices must be able to communicate flawlessly with host computers at high speeds. And application programs written by a burgeoning number of independent software developers must readily interchange ever-increasing amounts of data—and convert this fire hose of raw bits into meaningful information.

The secret to success? Standards.

Standards like the ISA and PCI backplane buses, RS-232 and GPIB networks, and DDE and OLE for application integration. As your partner in instrumentation and control, it is our responsibility to help ease your integration and communication tasks using standards wherever possible. You can also count on OMEGA's commitment to standards to preserve your freedom of choice and flexibility now and in the future. We'll never lock you into proprietary protocols.

Of course, the world of standards isn't perfect and standardization, by its very nature, lags the leading edge of technology. But rest assured that OMEGA will be with you every step of the way, helping to define the next generation of data acquisition standards to make your job easier, while continuing to support your ongoing requirements.

Mrs. Betty Ruth Hollander
Chairman-CEO
OMEGA Technologies

P.S. If you wish to submit an article of relevance for future issues of *Transactions*, please submit to my attention via mail (P.O. Box 4047, Stamford, CT 06907), FAX (203-359-7700), or e-mail (info@omega.com).

Exceeding Your Expectations

OMEGA's *Transactions in Measurement & Control* series, as well as our legendary set of handbooks and encyclopedias, are designed to provide at-your-fingertips access to the technical information you need to help meet your measurement and control requirements. But when your needs exceed the printed word—when technical assistance is required to select among alternative products, or when no “off-the-shelf” product seems to fill the bill—we hope you'll turn to OMEGA. There is no advertising or promotional materials in the *Transactions* series. There will be none.

Our people, our facilities, and our commitment to customer service set the standard for control and instrumentation. A sampler of our comprehensive resources and capabilities:

- OMEGA's commitment to leading-edge research and development and state-of-the-art manufacturing keeps us firmly at the forefront of technology. OMEGA's Development and Engineering Center, located on our Stamford, Conn., campus, is home to OMEGA's design and engineering laboratories. All product designs are tested and perfected here prior to marketing. This facility houses OMEGA's metrology lab and other quality control facilities. The testing that takes place here assures that you receive the best products for your applications.
- On the manufacturing side, our Bridgeport, N.J., vertically integrated manufacturing facility near Philadelphia houses advanced thermocouple wire production equipment along with a host of other computerized CNC milling machines, injection molding equipment, screw machines, braiders, extruders, punch presses and much, much more.
- If our broad range of standard products don't quite match your needs, OMEGA is proud to offer the most sophisticated and extensive custom engineering capabilities in the process measurement and control industry. Whether you need a simple modification of a standard product or complete customized system, OMEGA can accommodate your special request. Free CAD drawings also are supplied with customized product orders or a new design built to your specifications at no obligation.
- We believe in active versus reactive customer service. To complement our current business and manufacturing operations, OMEGA continues to strive toward new levels of quality by pursuing ISO 9000 quality standards. This systematic approach to quality strengthens OMEGA's competitive edge. Our calibration services and quality control test center are trustworthy resources that help satisfy our customers' needs for accuracy on an initial and ongoing basis.
- The company's technical center welcomes many corporate groups of engineers and scientists who turn to OMEGA for training. Our 140-seat auditorium, equipped with the latest in multimedia presentation technologies, provides an ideal learning environment for training tailored to your company's needs—from basic refreshers to in-depth courses.

In short, it is our commitment to quality instrumentation and exceptional customer service that remains the cornerstone of our success. OMEGA's priority is clear: we exist to facilitate solutions to your needs.

For more information about *Transactions* or OMEGA Technologies, look us up on the Internet at www.omega.com.



- Resolution & Aliasing
- Analog-to-Digital
- Digital-to-Analog

Analog I/O Functionality

Today, digital computers and other microprocessor-based devices have replaced analog recording and display technologies in all but the simplest data acquisition applications. And while computers have had an undeniably positive impact on the practice of data acquisition, they speak only a binary language of ones and zeroes.

(Figure 1-1) for converting analog and digital information about real-world processes and events into the language of computers.

Resolution & Aliasing

Most sensors for measuring temperature, pressure, and other continuous variables provide a continuously varying electrical output to repre-

sented as a digital number, however, this essentially continuous resolution is limited to discrete steps. This resolution of an A/D conversion often is stated in terms of bits—the more bits the finer the resolution. The number of bits determines the number of divisions into which a full-scale input range can be divided to approximate an analog input voltage. For example,

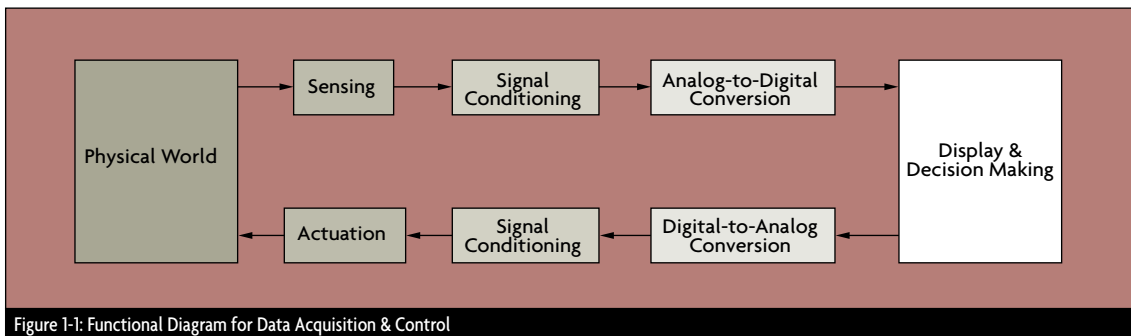

Figure 1-1: Functional Diagram for Data Acquisition & Control

Manufacturing processes and natural phenomena, however, are still by their very nature analog. That is, natural processes tend to vary smoothly over time, not discontinuously changing states from black to white, from on to off.

To be meaningfully recorded or manipulated by a computer then, analog measurements such as pressure, temperature, flow rate, and position must be translated into digital representations. Inherently digital events, too, such as the tripping of a motor or a pulse generated by a positive displacement flowmeter, must be made interpretable as a transistor-to-transistor logic (TTL) level changes in voltage. Hence, the origination and ongoing development of input/output (I/O) systems

sent the magnitude of the variable in question. To make this signal interpretable by a microprocessor, it must be converted from a smooth continuous value to a discrete, digital number (Figure 1-2).

This analog-to-digital (A/D) conversion process poses two primary challenges: one of quantization and one of sampling in time (Figure 1-3). Quantization refers to the uncertainty introduced upon conversion of an analog voltage to a digital number. Measurement transducers or transmitters typically provide continuously varying signals between 0-10 V dc, ±5 V dc, 0-100 mV dc, or 4-20 mA dc. Thermocouples and resistance temperature devices (RTDs) are other common low voltage inputs.

When this analog value is repre-

8-bit resolution of a 0-10 V input signal means that the range is divided into $2^8 = 256$ steps. This yields a step, or interval, size of $10 \text{ V} / 256 = 0.039 \text{ V}$. Thus, a 10-V input is equal to the digital number 255 and a 0-V input corresponds to 0. Each 0.039-V change in the input is indicated by adding or subtracting 1 from the previous number. (For example, 9.961 V is digitally represented by 254.)

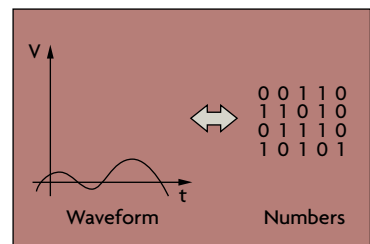
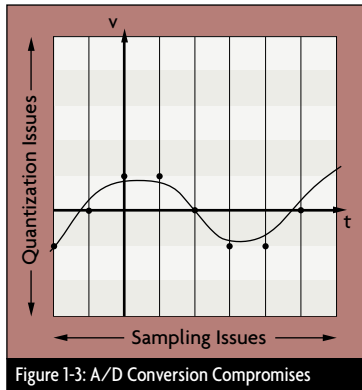

Figure 1-2: The Analog-to-Digital Interface



Digital data acquisition systems not only quantize data in terms of magnitude; time, too, is parceled into discrete intervals (Figure 1-3). In general, there is no information about the behavior of the process between data points gathered. Special precautions, then, must be taken to ensure no meaningful data is lost and interpolation between recorded points remains a valid assumption.

The Nyquist theorem defines the necessary relationship between the highest frequency contained in a signal and the minimum required sampling speed. Nyquist stated that the sample rate must be at least twice the highest frequency component contained within the input signal. So, to sample a 1-Hz sine wave, the sample rate should be at least 2 Hz. (But a rate of 8-16 Hz would be much better for resolving the true shape of the wave.)

The primary implications of ignoring the Nyquist criterion include not only missing high frequency information but of introducing aliasing; if the sample rate is not fast enough, the presence of totally nonexistent frequencies may be indicated (Figure 1-4). It is aliasing that makes a helicopter's rotors or a car's wheels appear to turn slowly backwards when seen in a movie. Low-pass, or

anti-aliasing filters can be used to limit the measured waveform's frequency spectrum so that no detectable component equals or exceeds half of the sampling rate.

Designing or specifying a device for A/D conversion consists of a series of trade-offs. As will be amply demonstrated in the next section, more resolution (more bits) means more accurate conversion but more expensive hardware. Similarly, slower sample rates mean cheaper A/D conversion, but the Nyquist criterion must still be satisfied.

A/D Conversion

Continuous electrical signals are converted to the digital language of computers using analog-to-digital (A/D) converters. An A/D converter may be housed on a PC board with associated circuitry or in a variety of remote or networked configurations. In addition to the converter itself, sample-and-hold circuits, an amplifier, a multiplexer, timing and synchronization circuits, and signal conditioning elements also may be on board (Figure 1-5). The logic circuits necessary to control the transfer of data to computer memory or to an internal register also are needed.

When determining what type of A/D converter should be used in a given application, performance should be closely matched to the requirements of the analog input transducer(s) in question. Accuracy, signal frequency content, maximum signal level, and dynamic range all should be considered.

Central to the performance of an A/D converter is its resolution, often expressed in bits. An A/D converter

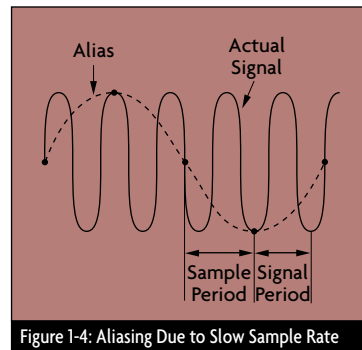

Figure 1-4: Aliasing Due to Slow Sample Rate

essentially divides the analog input range into 2^N bins, where N is the number of bits. In other words, resolution is a measure of the number of levels used to represent the analog input range and determines the converter's sensitivity to a change in analog input. This is not to be con-

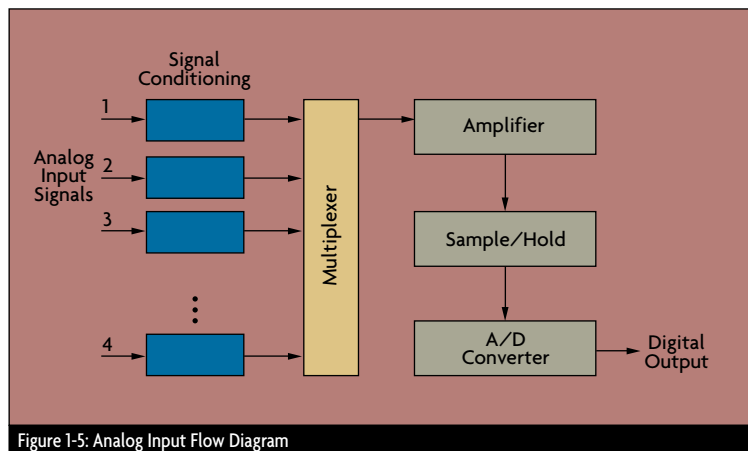

Figure 1-5: Analog Input Flow Diagram

fused with its absolute accuracy! Amplification of the signal, or input gain, can be used to increase the apparent sensitivity if the signal's expected maximum range is less than the input range of the A/D converter. Because higher resolution A/D converters cost more, it is especially important to not buy more resolution than you need—if you have 1% accurate (1 in 100) temperature transducers, a 16-bit (1 in 65,536) A/D converter is probably more resolution than you need.

Absolute accuracy of the A/D conversion is a function of the reference voltage stability (the known voltage to which the unknown voltage is compared) as well as the comparator performance. Overall, it is of limited use to know the accuracy of the A/D converter itself. Accuracy of the system, together with associated multiplexer, amplifier, and other circuitry is typically more meaningful.

The other primary A/D converter performance parameter that must be

the front-end analog circuitry to acquire a signal. Also called aperture time, it is the time for which the converter must see the analog voltage in order to complete a conversion.

for speed, others for economy, and others for a compromise among competing priorities (Figure 1-6). Industrial and lab data acquisition tasks typically require 12 to 16 bits—

Figure 1-6: Alternative A/D Converter Designs

DESIGN	SPEED	RESOLUTION	NOISE IMMUNITY	COST
Successive approximation	Medium	10-16 bits	Poor	Low
Integrating	Slow	12-18 bits	Good	Low
Ramp/counting	Slow	14-24 bits	Good	Medium
Flash/parallel	Fast	4-8 bits	None	High

- **Conversion** is the time needed to produce a digital value corresponding to the analog value.
 - **Transfer** is the time needed to send the digital value to the host computer's memory.
- Throughput, then, equals the number of channels being served divided by the time required to do all three functions.

A/D Converter Options

While all analog-to-digital converters are classified by their resolution or number of bits, how the A/D cir-

12 is the most common. As a rule, increasing resolution results in higher costs and slower conversion speed.

- **Successive approximation:** The most common A/D converter design used for general industrial and laboratory applications is successive approximation (Figure 1-7). This design offers an effective compromise among resolution, speed, and cost. In this type of design, an internal digital-to-analog (D/A) converter and a single comparator—essentially a circuit that determines which of two voltages is higher—are used to narrow in on the unknown voltage by turning bits in the D/A converter on until the voltages match to within the least significant bit. Raw sampling speed for successive approximation converters is in the 50 kHz to 1 MHz range.

To achieve higher sampling speeds, a redundancy technique allows a fast initial approximate conversion, followed by a correction step that adjust the least significant bit after allowing sufficient settling time. The conversion is therefore completed faster at the expense of additional hardware. Redundancy is useful when both high speed and high resolution are desirable.

- **Flash/parallel:** When higher speed operation is required, parallel, or flash-type A/D conversion is called

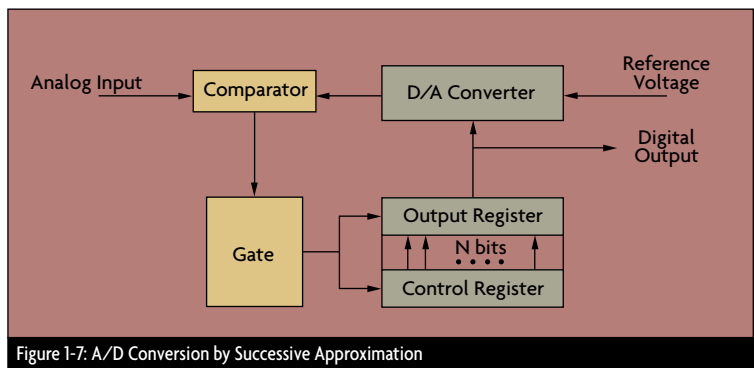

Figure 1-7: A/D Conversion by Successive Approximation

considered is speed—throughput for a multi-channel device. Overall, system speed depends on the conversion time, acquisition time, transfer time, and the number of channels being served by the system:

- **Acquisition** is the time needed by

circuitry achieves this resolution varies from device to device. There are four primary types of A/D converters used for industrial and laboratory applications—successive approximation, flash/parallel, integrating, and ramp/counting. Some are optimized

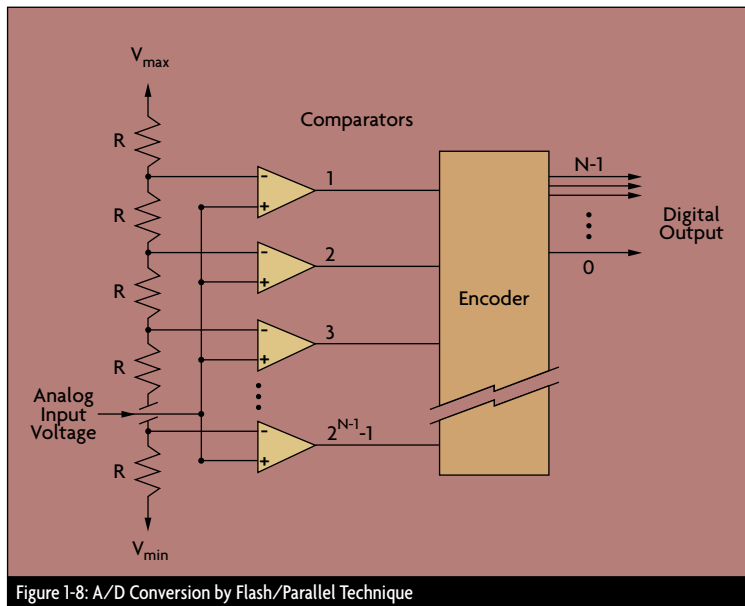

Figure 1-8: A/D Conversion by Flash/Parallel Technique

for. This design uses multiple comparators in parallel to process samples at more than 100 MHz with 8 to 12-bit resolution. Conversion is accomplished by a string of comparators with appropriate references operating in parallel (Figure 1-8).

The downside of this design is the large number of relatively expensive comparators that are required—for example, a 12-bit converter requires 4,095 comparators.

- **Integrating:** This type of A/D converter integrates an unknown input voltage for a specific period of time, then integrates it back down to zero. This time is compared to the amount of time taken to perform a similar integration on a known reference voltage. The relative times required and the known reference voltage then yield the unknown input voltage. Integrating converters with 12 to 18-bit resolution are available, at raw sampling rates of 10-500 kHz.

Because this type of design effectively averages the input voltage over time, it also smoothes out sig-

nal noise. And, if an integration period is chosen that is a multiple of the ac line frequency, excellent common mode noise rejection is achieved. More accurate and more linear than successive approximation converters are a good choice for low-level voltage signals.

- **Ramp/counter:** Similar to successive approximation designs, counting or ramp-type A/D converters use one comparator circuit and a D/A converter (Figure 1-9). This design progressively increments a digital counter and with each new count generates the corresponding analog

voltage and compares it to the unknown input voltage. When agreement is indicated, the counter contains the digital equivalent of the unknown signal.

A variation on the counter method is the ramp method, which substitutes an operational amplifier or other analog ramping circuit for the D/A converter. This technique is somewhat faster.

Multiplexing & Signal Conditioning

As shown in Figure 1-5, A/D converters seldom function on their own but must be considered in a systems context with associated circuitry for signal conditioning, multiplexing, amplification, and other functions. Every application will dictate a unique mix of add-ons that may be implemented in a variety of physical configurations—on a PC I/O board, inside a remote transmitter, or at a local termination panel.

- **Multiplexing:** In many industrial and laboratory applications, multiple analog signals must be converted to digital form. And if speed is not the limiting factor, a single A/D converter often is shared among multiple input channels via a switching mechanism called a multiplexer. This is commonly done because of the relatively high cost of converters. Multiplexers also allow amplification and other signal conditioning circuitry

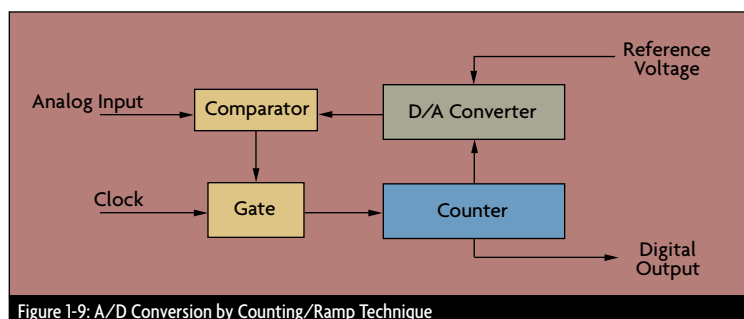

Figure 1-9: A/D Conversion by Counting/Ramp Technique

to be time-shared among multiple channels. Software or auxiliary hardware controls the switch selection.

- **Sample-and-hold:** It is important to acknowledge that a multiplexer

capacitor on each channel tracks the corresponding input signal. Before starting the A/D conversion process, all switches are opened simultaneously, leaving the last instantaneous

er behave more like an 18-bit converter. This function does, however, slow down the sample rate.

From a systems perspective, amplifier performance should be on par with that of the A/D converter itself—gain accuracy should be specified as a low percentage of the total gain. Amplifier noise and offset error also should be low.

- **Other conditioning functions:** Other A/D signal conditioning functions required will vary widely from application to application. Among the options:

- **Current-to-voltage conversion:** A 4-20 mA current signal can be readily converted to a voltage signal using a simple resistor (Figure 1-11). A resistor value of 250 ohms will yield a 1-5 V output.
- **Filtering:** A variety of physical devices and circuits are available to help separate desired signals from specific frequencies of undesirable electrical noise such as ac

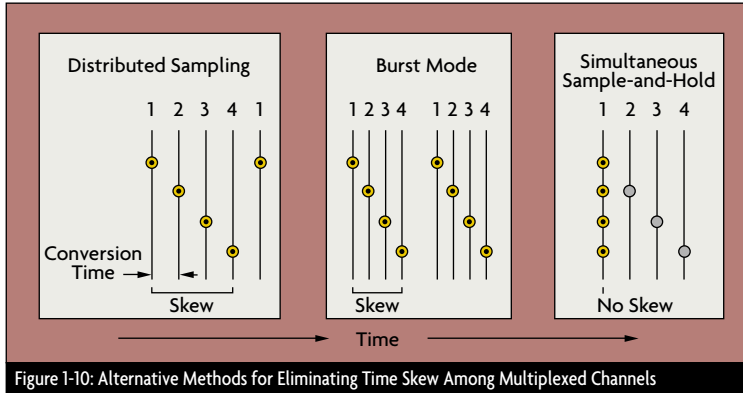

Figure 1-10: Alternative Methods for Eliminating Time Skew Among Multiplexed Channels

does reduce the frequency with which data points are acquired, and that the Nyquist sample-rate criterion still must be observed. During a typical data acquisition process, individual channels are read in turn sequentially. This is called standard, or distributed, sampling. A reading of all channels is called a scan. Because each channel is acquired and converted at a slightly different time, however, a skew in sample time is created between data points (Figure 1-10).

If time synchronization among inputs is important, some data acquisition cards offer “burst” mode operation or simultaneous “sample-and-hold” circuitry. Burst mode, or pseudo-simultaneous sampling, acquires each channel at the maximum rate of the board, then waits a user-specified amount of time before sampling again.

True simultaneous sample-and-hold systems can sample all channels within a few nanoseconds of each other, eliminating phase and time discontinuities for all but the fastest processes. Essentially, a switched

values on the capacitors.

- **Signal scaling:** Because A/D converters work best on signals in the 1-10 V range, low voltage signals may need to be amplified before conversion—either individually or after multiplexing on a shared circuit. Conversely, high voltage signals may need to be attenuated.

Amplifiers also can boost an A/D converter’s resolution of low-level signals. For example, a 12-bit A/D converter with a gain of 4 can digitize a signal with the same resolution as a 14-bit converter with a gain of 1. It’s important to note, however, that fixed-gain amplifiers, which essentially multiply all signals proportionately, increase sensitivity to low voltage signals but do not extend the converter’s dynamic range.

Programmable gain amplifiers (PGAs), on the other hand, can be configured to automatically increase the gain as the signal level drops, effectively increasing the system’s dynamic range. A PGA with three gain levels set three orders of magnitude apart can make a 12-bit convert-

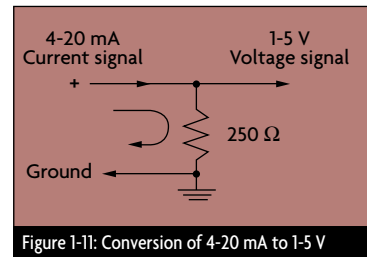

Figure 1-11: Conversion of 4-20 mA to 1-5 V

line pick-up and other electromagnetic/radio frequency interference (EMI/RFI). If the signal of interest is lower in frequency than the noise, a low-pass filter can be used. High-pass and notch-band filters are designed to target low frequency interference and specific frequency bands, respectively.

- **Excitation:** Voltage supplied by the data acquisition card or discrete signal conditioner to certain types of

transducers such as strain gages.

- Isolation: Used to protect personnel and equipment from high voltages. Isolators block circuit overloads while simultaneously passing the signal of interest.

Single-Ended & Differential Inputs

Another important consideration when specifying analog data acquisition hardware is whether to use single-ended or differential inputs (Figure 1-12). In short, single-ended inputs are less expensive but can be problematic if differences in ground potential exist.

In a single-ended configuration, the signal sources and the input to the amplifier are referenced to ground. This is adequate for high level signals when the difference in ground potential is relatively small. A difference in ground potentials, however, will create an error-causing current flow through the ground conductor otherwise known as a ground loop.

Differential inputs, in contrast, connect both the positive and negative inputs of the amplifier to both ends of the actual signal source. Any ground-loop induced voltage appears in both ends and is rejected

as a common-mode noise. The downside of differential connections

under test. Digital-to-analog (D/A) conversion is in many ways the con-

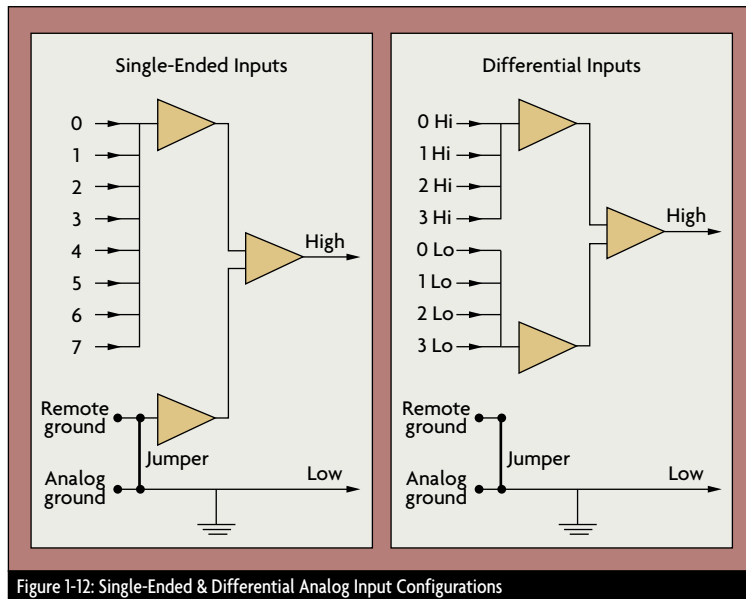

Figure 1-12: Single-Ended & Differential Analog Input Configurations

is that they are essentially twice as expensive as single-ended inputs; an eight-channel analog input board can handle only four differential inputs.

D/A Conversion

Analog outputs commonly are used to operate valves and motors in industrial environments and to generate inputs for electronic devices

verse of A/D conversion, but tends to be generally more straightforward. Similar to analog input configurations, a common D/A converter often is shared among multiplexed output signals. Standard analog output ranges are essentially the same as analog inputs: ± 5 V dc, ± 10 V dc, 0-10 V dc, and 4-20 mA dc.

Essentially, the logic circuitry for

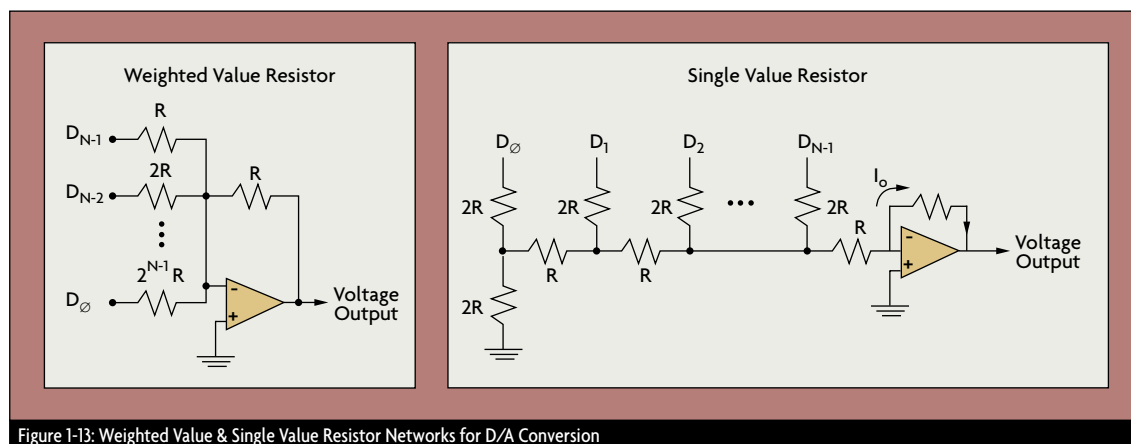

Figure 1-13: Weighted Value & Single Value Resistor Networks for D/A Conversion

an analog voltage output uses a digital word, or series of bits, to drop in (or drop out, depending on whether the bit is 1 or 0) a series of resistors from a circuit driven by a reference voltage. This ladder of resistors can be made of either weighted value resistors or an R-2R network using only two resistor values—one if placed in series (Figure 1-13). While operation of the weighted-value network is more intuitively obvious, the R-2R scheme is more practical. Because only one resistor value need be used, it is easier to match the temperature coefficients of an R-2R ladder than a weighted network, resulting in more accurate outputs. Plus, for high resolution outputs, very high resistor values are needed in the weighted-resistor approach.

Key specifications of an analog output include:

- **Settling time:** Period required for a D/A converter to respond to a full-scale setpoint change.
- **Linearity:** This refers to the device's ability to accurately divide the reference voltage into evenly sized increments.

- **Range:** The reference voltage sets the limit on the output voltage achievable.

Because most unconditioned analog outputs are limited to 5 mA of

current, amplifiers and signal conditioners often are needed to drive a final control element. A low-pass filter may also be used to smooth out the discrete steps in output. **T**

References & Further Reading

- *The Data Acquisition Systems Handbook*, Omega Press LLC, 1997.
- *New Horizons in Data Acquisition and Computer Interfaces*, Omega Press LLC, 1997.
- *Omega® Universal Guide to Data Acquisition and Computer Interfaces*, Omega Press LLC, 1997.
- *Analog I/O Design: Acquisition, Conversion, Recovery*, Patrick Garrett, Reston Publishing Co., 1981.
- *Analog Signal Processing and Instrumentation*, Arie F. Arbel, Cambridge University Press, 1980.
- *Analog-To-Digital and Digital-To-Analog Conversion Techniques*, David Hoeschele, John Wiley & Sons, 1994.
- *Analog-To-Digital Conversion: A Practical Approach*, Kevin M. Daugherty, McGraw Hill, 1995.
- *Automation Systems for Control and Data Acquisition*, Lawrence T. Amy, ISA, 1992.
- *Data Acquisition and Control, Microcomputer Applications for Scientists and Engineers*, Joseph J. Carr, Tab Books Inc., 1988.
- *Data Acquisition and Process Control Using Personal Computers*, Tarik Ozkul, Marcel Dekker, 1996.
- *Instrument Engineers' Handbook, Third Edition*, Bela Liptak, Chilton Book Co., 1995.
- *Process/Industrial Instruments & Controls Handbook, Fourth Edition*, Douglas M. Considine, McGraw-Hill Inc., 1993.

Digital I/O Functionality

In contrast to analog transducers that sense continuous variables such as pressure and temperature, many transducers provide an output that is one of two states: high or low, open or closed. A pressure might be too high or a

processor-based data acquisition systems to deal with than analog signals. Similar to analog-to-digital converters used for analog I/O, digital I/O is designed to deal directly with transistor-to-transistor logic (TTL) level voltage changes. TTL

a digital change of state from high to low, on to off, etc.

And because acquiring an analog signal is more complex than acquiring a digital one, analog I/O channels also are more expensive. Hence, if digital I/O is adequate, do not bother with analog.

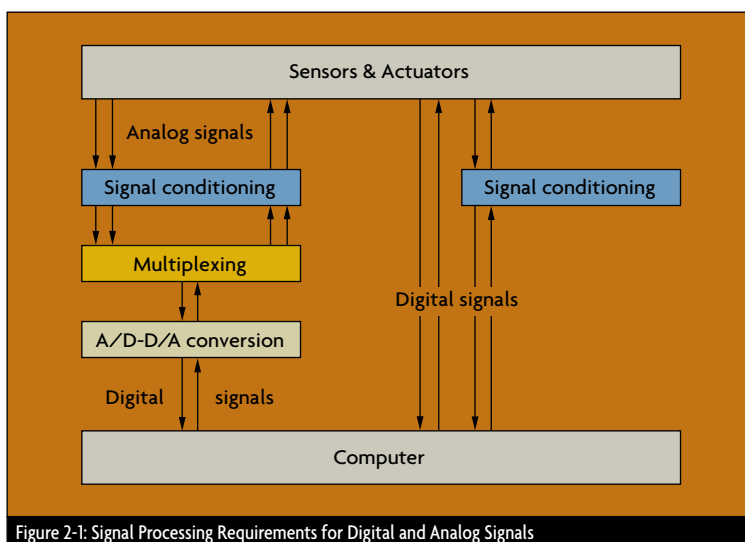

Figure 2-1: Signal Processing Requirements for Digital and Analog Signals

temperature too low, triggering closure of a switch. Outputs, too, are not strictly analog—solenoid valves typically are opened or closed, many pumps and heaters are simply turned on or off. Pulse signals are another form of digital I/O, with one rotation of a turbine flowmeter or tachometer corresponding to a single, countable event. Digital I/O also can be used for parallel communications among plug-in expansion cards, and to generate clock and other timing signals.

Already in the binary language of computers, these types of digital, or discrete, inputs and outputs (I/O) are much easier for micro-

typically sets the low voltage level between 0 and 0.8 V and the high voltage level between 2.0 and 5.0 V. Voltage levels between 0.8 and 2.0 V are not allowed. A voltage change, then, from the high range to the low range (or vice versa) represents

Digital Inputs

Many types of digital input signals from switch closures, relay contacts, or TTL-compatible interfaces can be read directly by digital I/O cards (Figure 2-1). Other types of inputs may require some signal conditioning, most likely to reduce higher-level voltage changes to TTL levels. A variety of signal conditioning modules are available to provide isolation and other digital conditioning functions.

The most common type of digital input is the contact closure (Figure 2-2). Essentially a sensor or switch of some type closes or opens a set of contacts in accordance with some process change. An applied electrical signal then determines whether the circuit is open or closed. Current flows if the circuit is closed, registering a “1” in a transistor at the computer interface. Conversely, an open circuit

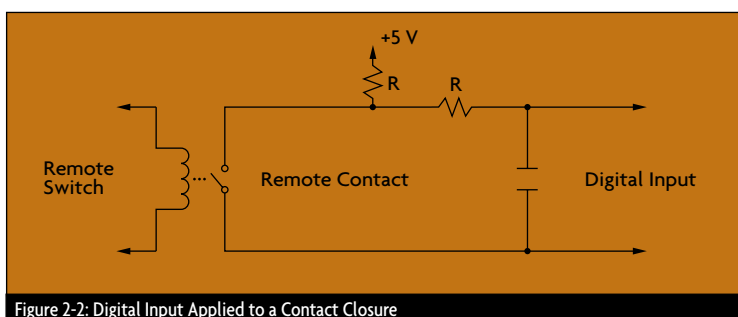

Figure 2-2: Digital Input Applied to a Contact Closure

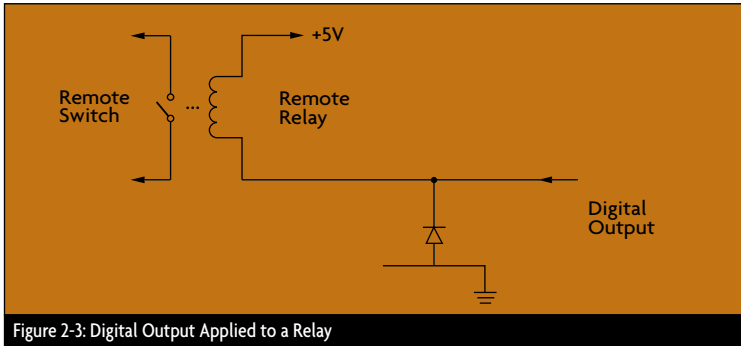

Figure 2-3: Digital Output Applied to a Relay

retains a high voltage (and no current), registering a “0” at the transistor.

Another type of digital input useful in data acquisition applications is the hardware trigger. This allows an external event—a high reactor temperature, perhaps, or a low tank level—to control data collection. If during routine operation data is only being acquired for archival storage on a once-per-second basis, a hardware trigger can be used to boost the data acquisition rate during an upset until normal conditions are restored.

Digital Outputs

At its simplest, a digital output provides a means of turning something on or off. Applications range from driving a relay to turning on an indicator lamp to transmitting data to another computer. For latching outputs, a “1” typically causes the associated switch or relay to latch, while a “0” causes the switch to unlatch. Devices can be turned on or off, depending on whether the external contacts are normally open or normally closed.

Standard TTL level signals can be

used to drive 5-V relay coils; a protective diode is used to protect the digital output circuitry (Figure 2-3). Because data acquisition boards can typically supply only 24 mA of driving current, they are intended primarily to drive other logic circuits, not final control elements. Scaling may be needed so that logical voltage levels are sufficient to cause switching in larger relays. Outputs intended to drive larger solenoids, contactors, motors, or alarms also may require a boost.

Pulse I/O

A somewhat separate class of digital I/O is pulse inputs and outputs, which typically is associated with frequency, counting, or totalization applications. Pulse inputs might be used to count the rotations of a turbine flowmeter; pulse outputs might be used to drive a stepping motor.

Pulse inputs are handled in much the same way as digital logic inputs, but the output of the sensing circuit is normally connected to a counter rather than a specific bit position in the input register. Successive pulses increment or decrement the counter. Add an elapsed time measure and a frequency or pulse rate can readily be determined. Similar to an analog-to-digital converter, a counter is characterized by its number of bits—an N-bit counter can accumulate up to 2^N discrete events. Thus, a 16-bit counter can count to $2^{16} = 65,536$.

References & Further Reading

- *The Data Acquisition Systems Handbook*, Omega Press LLC, 1997.
- *New Horizons in Data Acquisition and Computer Interfaces*, Omega Press LLC, 1997.
- *Omega® Universal Guide to Data Acquisition and Computer Interfaces*, Omega Press LLC, 1997.
- *Automation Systems for Control and Data Acquisition*, Lawrence T. Amy, ISA, 1992.
- *Data Acquisition and Control, Microcomputer Applications for Scientists and Engineers*, Joseph J. Carr, Tab Books Inc., 1988.
- *Data Acquisition and Process Control Using Personal Computers*, Tarik Ozkul, Marcel Dekker, 1996.
- *Instrument Engineers' Handbook, Third Edition*, Bela Liptak, Chilton Book Co., 1995.
- *Process/Industrial Instruments & Controls Handbook, Fourth Edition*, Douglas M. Considine, McGraw-Hill Inc., 1993.

Analog Signal Transmission

Although the microprocessor and digital network technologies have fundamentally reinvented the ways in which today's data acquisition systems handle data, much laboratory and manufacturing information is still communicated the "old" way, via analog electrical signals. And a fundamental understanding of how analog signal transmission works must first begin with a discussion of electrical basics.

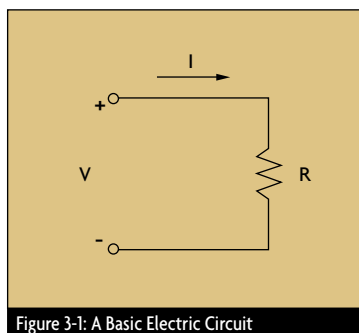

Figure 3-1: A Basic Electric Circuit

To understand the ways in which an analog signal is transmitted over a circuit, it is first important to understand the relationships that make analog signal transmission possible. It is the fundamental relationship between voltage, current, and electrical resistance (Figure 3-1) that allow either a continuously varying current or voltage to represent a continuous process variable.

While charge flow is electric current, voltage is the work done in moving a unit of charge (1 coulomb) from one point to another. The unit of voltage is often called the potential difference, or the volt (V). The International System of Units (SI) unit for electrical flow is the

ampere (A), defined as one coulomb per second (c/s).

A signal source of voltage, V , will cause a current, I , to flow through a resistor of resistance, R . Ohm's law, which was formulated by the German physicist Georg Simon Ohm (1787-1854), defines the relation:

$$V = IR$$

While most single-channel analog signal transmissions use direct current (dc) variations in current or voltage to represent a data value, frequency variations of an alternating current (ac) also can be used to communicate information. In the early 19th century, Jean Baptiste Joseph Fourier, a French mathematician and physicist, discovered that ac signals could be defined in terms of sine waves. A sine wave is described by three quantities: amplitude, period, and frequency. The amplitude is the peak value of the wave in either the positive or negative direction, the period is the time it takes to complete one cycle of the wave, and the frequency is the number of complete

cycles per unit of time (the reciprocal of the period).

Analog Signal Types

Most data acquisition signals can be described as analog, digital, or pulse. While analog signals typically vary smoothly and continuously over time, digital signals are present at discrete points in time (Figure 3-2). In most control applications, analog signals range continuously over a specified current or voltage range, such as 4-20 mA dc or 0 to 5 V dc. While digital signals are essentially on/off (the pump is on or off, the bottle is there or isn't), analog signals represent continuously variable entities such as temperatures, pressures, or flow rates. Because computer-based controllers and systems understand only discrete on/off information, conversion of analog signals to digital representations is necessary (and discussed in Chapter 1).

Transduction is the process of changing energy from one form into another. Hence, a transducer is a device that converts physical energy into an electrical voltage or current signal for transmission. There

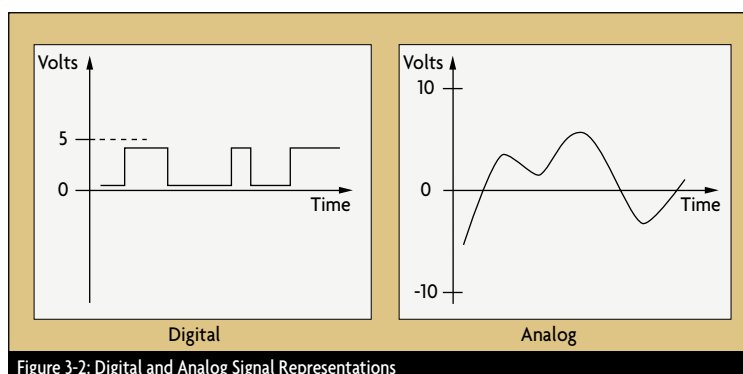
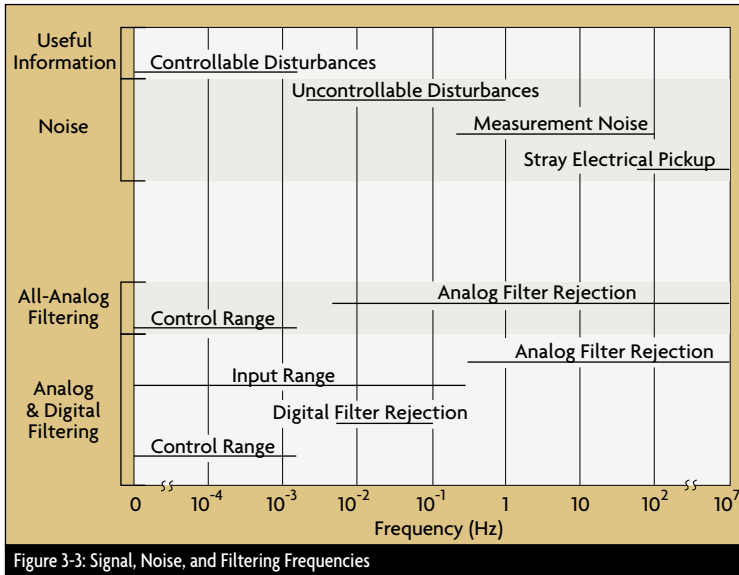

Figure 3-2: Digital and Analog Signal Representations



- Leakage paths at the input terminals;
- Turbulent signals from other instruments;
- Electrical charge pickup from power sources;
- Switching of high-current loads in nearby wiring;
- Self-heating due to resistance changes;
- Arcs;
- Lightning bolts;
- Electrical motors;
- High-frequency transients and pulses passing into the equipment;
- Improper wiring and installation;
- Signal conversion error; and
- Uncontrollable process disturbances.

are many different forms of analog electrical transducers. Common transducers include load cells for measuring strain via resistance, and thermocouples and resistance temperature detectors (RTDs) for measuring temperature via voltage and resistance measurement, respectively. Transmission channels may be wires or coaxial cables.

For noise-resistant transmission over significant distances, the raw transducer signal is often converted to a 4-20 mA signal by a two-wire, loop-powered transmitter. The bottom value of a process variable's range, for example, a temperature, is typically designated as 4 mA, making it easy to distinguish transmitter failure (0 mA) from a valid signal. If the current source is of good quality, current loops tend to be less sensitive to noise pickup by electromagnetic interference than voltage-based signals.

Noise & Grounding

In transmitting analog signals across a process plant or factory floor, one

of the most critical requirements is the protection of data integrity. However, when a data acquisition system is transmitting low level analog signals over wires, some signal degradation is unavoidable and will occur due to noise and electrical interference. Noise and signal degradation are two basic problems in analog signal transmission.

Noise is defined as any unwanted electrical or magnetic phenomena that corrupt a message signal. Noise can be categorized into two broad categories based on the source—internal noise and external noise. While internal noise is generated by components associated with the signal itself, external noise results when natural or man-made electrical or magnetic phenomena influence the signal as it is being transmitted. Noise limits the ability to correctly identify the sent message and therefore limits information transfer. Some of the sources of internal and external noise include:

- Electromagnetic interference (EMI);
- Radio-frequency interference (RFI);

Signal leads can pick up two types of external noise—common mode and normal mode. Normal mode noise enters the signal path as a differential voltage and cannot be distinguished from the transducer signal. Noise picked up on both leads from ground is referred to as common-mode interference.

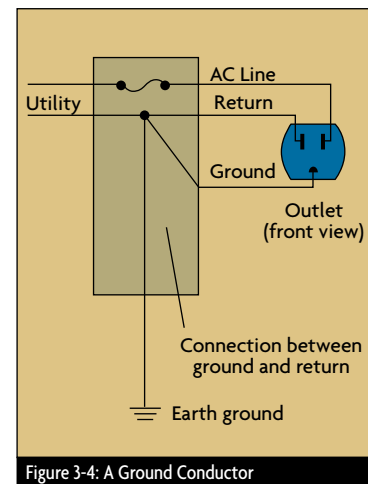

Typical ranges for data signals and noise are shown in Figure 3-3. Whether the noise is detrimental to the proper performance of the system depends on the ratio of the total

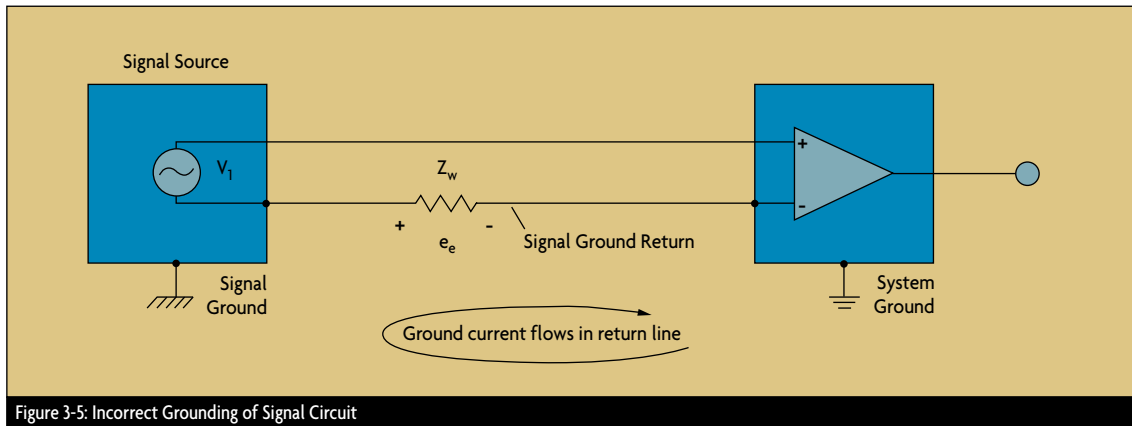

Figure 3-5: Incorrect Grounding of Signal Circuit

signal power to the total noise level. This is referred to as the signal-to-noise ratio. If the signal power is large in comparison to the noise signal, the noise can often times be ignored. However, with long-distance signals operating with limited signal power, the noise may disrupt the signal completely.

Current-driven devices have been most widely accepted in processing plants, with a common current range of 4-20 mA. Low-level current signals are not only safe, but are not as susceptible to noise as voltage signals. If a current is magnetically coupled into the connecting wires in the transmission of the signal from a current source, no significant change in the signal current will result. If the

transducer is a voltage-driven device, the error adds directly to the signal. After current transmission, voltage signals can be easily rederived.

Even though internal and external interference can be problematic in sending analog signals, analog signal transmission is widely and successfully used in industry. The effects of noise can be reduced with careful engineering design, proper installation, routing techniques of wires and cables, and shielding and grounding.

One of the ways in which engineers have tried to minimize the effects of noise is to maximize the signal-to-noise ratio. This involves increasing the power of the signal being sent. Although this works in some cases, it has its limitations. By increasing the

signal, nonlinear effects become dominant, as the signal amplitude is increased—it enhances the signal and the noise in the same proportion.

Proper grounding also is essential for effective operation of any measurement system. Improper grounding can lead to potentially dangerous ground loops and susceptibility to interference. To understand the principles involved in shielding and grounding, some terms must first be understood. A ground is a conducting flow path for current between an electric circuit and the earth. Ground wires are typically made with materials that have very low resistance. Because current takes the path of least resistance, the ground wires connected from the system provide

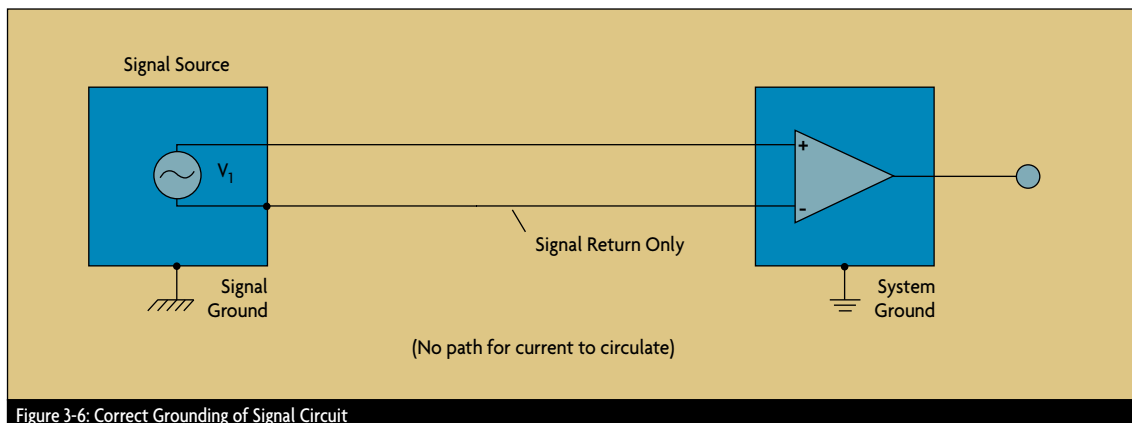

Figure 3-6: Correct Grounding of Signal Circuit

a stable reference for making voltage measurements. Ground wires also safeguard against unwanted common-mode signals and prevent accidental contact with dangerous voltages. Return lines carry power or signal currents (Figure 3-4). A ground loop is a potentially dangerous loop formed when two or more points in an electrical system are grounded to different potentials.

There are many different grounding techniques designed to not only protect the data being transmitted, but to protect employees and equipment. There are two ways in which all systems should be grounded. First of all, all of the measuring equipment and recording systems should be grounded so that measurements can be taken with respect to a zero voltage potential. This not only ensures that potential is not being introduced at the measuring device, but ensures that enclosures or cabinets around equipment do not carry a voltage. To ground an enclosure or cabinet, one or more heavy copper conductors are run from the device to a stable ground rod or a designated ground grid. This system ground provides a base for rejecting common-mode noise signals. It is very important that this ground is kept stable.

The second ground is for the signal ground. This ground is necessary to provide a solid reference for the measurement of all low-level signals. It is very important that this ground is grounded separate and isolated from the system ground. If a signal return line is grounded at the signal source and at the system ground, a difference in potential between the two grounds may cause a circulating current (Figure 3-5). In this case, the circulating current will be in series

with the signal leads and will add directly to the signal from the measuring instrument. These ground loops are capable of creating noise signals 100 times the size of the original signal. This current can also be potentially dangerous. In a single-point ground configuration, minimal current can flow in the ground reference. Figure 3-6 shows that by grounding the wire at the signal end only, the current has no path, eliminating the ground loop.

that require high precision and accuracy, the third signal lead, or shield, is necessary. In the three-wire configuration, the shield is grounded at the signal source to reduce common-mode noise. However, this does not eliminate all of the possibilities of the introduction of noise. It is crucial to prevent the noise pickup by protecting the signal lines. For example, in the case where the noise and signal frequency are the same. In this scenario, the signal cannot be isolat-

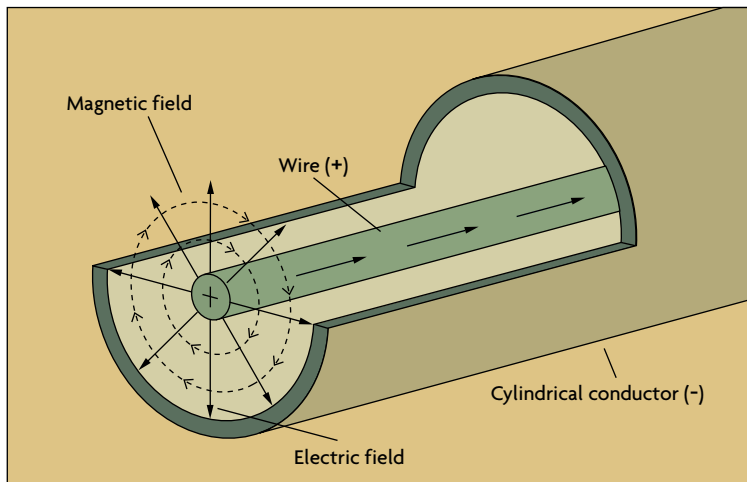

Figure 3-7: Coaxial Cable Construction

For off-ground measurements, the shield or the ground lead is stabilized with respect to either the low-level of the signal or at a point between the two. Because the shield is at a potential above the zero-reference ground, it is necessary to have proper insulation.

Wire & Cable Options

Another important aspect to consider in analog signal transmission is a proper wiring system, which can effectively reduce noise interference. Analog signal transmission typically consists of two-wire signal leads or three-wire signal leads. In systems

ed/filtered from the noise at the receiving device.

Generally, two-wire transmission mediums are used to carry an analog signal to or from the field area. A wire carrying an alternating current and voltage may induce noise in a pair of nearby signal leads. A differential voltage/noise will be created since the two wires may be at different distances from the disturbing signal. There are many different wiring options that are available to reduce unwanted noise pickup from entering the line. Four types of wires are fundamental in data acquisition—plain pair, shielded pair, twisted pair, and coaxial cable.

While plain wire can be used, it is generally not very reliable in screening out noise and is not suggested. A shielded pair is a pair of wires surrounded by a conductor that does not carry current. The shield blocks the interfering current and directs it to the ground. When using shielded pair, it is very important to follow the rules in grounding. Again, the shield must only be grounded at one source, eliminating the possibility of ground-loop currents.

Twisted-pairs help in elimination of noise due to electromagnetic fields by twisting the two signal leads at regular intervals. Any induced disturbance in the wire will have the same magnitude and result in error cancellation.

A coaxial cable is another alternative for protecting data from noise. A coaxial cable consists of a central conducting wire separated from an outer conducting cylinder by an insulator. The central conductor is positive with respect to the outer conductor and carries a current (Figure 3-7). Coaxial cables do not produce external electric and magnetic fields and are not affected by them. This makes them ideally suited, although more expensive, for transmitting signals.

Although noise and interference

cannot be completely removed in the transmission of an analog signal, with good engineering and proper

installation, many of the effects of noise and interference can be substantially reduced. 

References & Further Reading

- *Analog Signal Processing and Instrumentation*, Arie F. Arbel, Cambridge University Press, 1980.
- *Basic Circuit Analysis*, David R. Cunningham, and John A. Stuller, Houghton Mifflin Co., 1932.
- *Circuits: Principles, Analysis, and Simulation*, Frank P. Yatsko, and David M. Hata, Saunders College Publishing, 1992.
- *Data Acquisition and Control, Microcomputer Applications for Scientists and Engineers*, Joseph J. Carr, Tab Books Inc., 1988.
- *Data Communications, A Beginner's Guide to Concepts and Technology*, Scott A. Helmers, Prentice-Hall, Inc., 1989.
- *Digital and Analog Communication Systems*, K. Sam Shanmugam, John Wiley & Sons, 1979.
- *Fundamentals of Transducers*, Stan Gibilisco and R. H. Warring, Tab Books Inc., 1985.
- *Instrument Engineers' Handbook, Third Edition*, Bela Liptak, Chilton Book Co., 1995.
- *Introduction to Signal Transmission*, Electrical and Electronic Engineering Series, William R. Bennett, McGraw-Hill, 1970.
- *Microprocessors in Industrial Measurement and Control*, Marvin D. Weiss, Tab Books Inc., 1987.
- *Modern Digital and Analog Communication Systems*, B.P. Lathi, Holt, Rinehart, & Winston, 1983.
- *Process/Industrial Instruments & Controls Handbook, Fourth Edition*, Douglas M. Considine, McGraw-Hill Inc., 1993.
- *Signals & Systems Made Ridiculously Simple*, Zohey Z. Karu, Zi Zi Press, 1995.
- *Signals, The Telephone and Beyond*, John R. Pierce, W. H. Freeman and Co., 1981.

- Physical Layer Options
- Network Topologies
- Fieldbus & Device Networks

Digital Signal Transmission

Industrial networks that transmit data using digital signals often are an integral part of a data acquisition or process control solution. A basic understanding of the network technologies that are available for various applications is required to make the best implementation decisions—decisions that can have a profound effect on the ability to adapt to ever-changing technologies.

For example, the type of network(s) or network products selected for a data acquisition application can greatly affect cost/benefit evaluations for future projects. Until recently, fiber optics were an expensive option that seemed like overkill for most applications. But with the information load now likely to flow between nodes on an enterprise network, fiber looks attractive.

Network technologies come in a bewildering array of options, and certain segments of this technology are changing at an incredible rate. The average user might spend weeks researching the various ways to build or improve a network, just to find that once a decision is made and products are purchased, the next wave of bigger, better, faster technology is now available.

A well-designed, integrated solution to data transmission will yield a competitive advantage to any industrial enterprise. Users in all aspects of a business should be able to obtain plant and business data from any physical node, local or remote. “Gluing” pieces of new and/or existing networks together is becoming more feasible with the use of bridging, routing, and media conversion

technologies that link local area, wide area, and industrial networks together. And with Internet and wireless technologies, data transmission over large geographic areas is increasingly feasible.

The OSI Network Model

Nearly all digital network descriptions start with the OSI (Open Systems Interconnect) model (Figure 4-1). It explains the various “layers” of network technology. To the casual user, this model is a little abstract, but there is not a better way to begin to understand what is going on.

Sometimes it helps to understand each layer by examining the technology it represents. The Application Layer is the most intuitive because it is what the user sees. It represents

the Internet. In an industrial application, a program on a programmable logic controller (PLC) might control a smart valve.

The Presentation Layer performs formatting on the data going to and from the application. This layer performs such services such as encryption, compression, and conversion of data from one form to another. For example, an application (one layer up) might send a time stamp formatted in 12-hour time: 01:30:48 p.m. A more universal representation is 13:30:48, in 24-hour time, which can be accepted or presented at the next node’s application in the form that it needs. One advantage to presentation services is that they help eliminate overhead, or embedded services, in application programs.

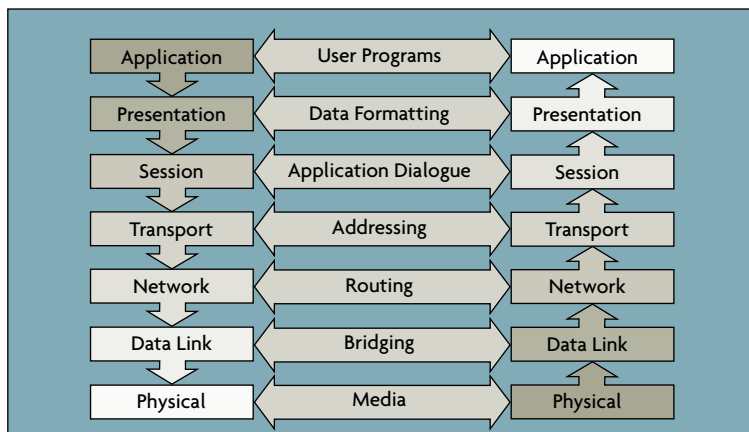

Figure 4-1: The Seven-Layer OSI Network Model

the problem the user wants the system to solve. Internet browsers and e-mail programs are good examples. They allow the user to input and read data while connected between a client PC and a server somewhere on

The Session Layer establishes the connection between applications. It also enforces dialogue rules, which specify the order and speed of data transfer between a sender and a receiver. For example, the session

layer would control the flow of data between an application and a printer with a fixed buffer, to avoid buffer overflows. In the time stamp example, once the data is presented in 24-hour time format, an identifier and length indicator are appended to the data string.

The Transport Layer is essentially an interface between the processor and the outside world. It generates addresses for session entities and ensures all blocks or packets of data have been sent or received. In the time stamp example, an address for each session entity (sender and receiver) and checksum are appended to the block generated by the session layer.

The Network Layer performs accounting, addressing, and routing functions on messages received from the transport layer. If the message is lengthy, this layer will break it up and sequence it over the network. This layer also uses a network routing table to find the next node on the way to the destination address. In the time stamp example, a node address and sequence number are appended to the message received from the session layer.

The Data Link Layer establishes and controls the physical path of communication from one node to the next, with error detection. This layer performs media access control (MAC) to decide which node can use the media and when. The rules used to perform these functions also are known as protocols. Ethernet and token ring contention are examples of protocols. In the time stamp example, a header and trailer are appended to the message received from the transport layer for flagging the beginning and end of the frame, type of frame (control or data),

checksum, and other functions.

The Physical Layer is perhaps the most conspicuous layer from a cost point of view. It is relatively easy to understand the labor and material

proprietary network, or where the network services are bundled in a black-box fashion with the device.

The most common serial data exchange interfaces are RS-232,

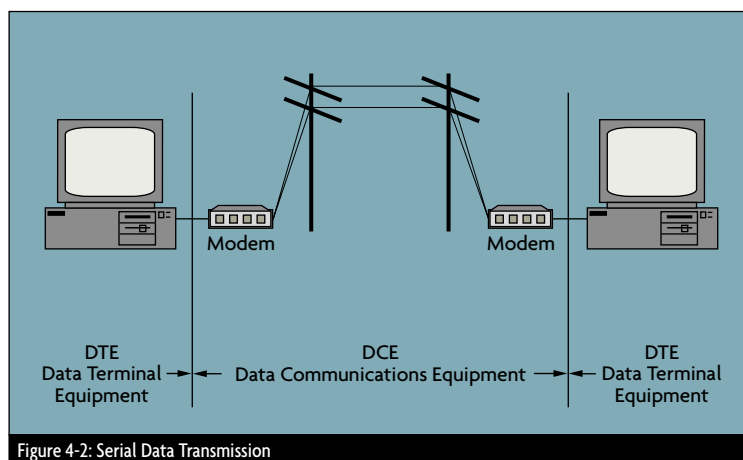

Figure 4-2: Serial Data Transmission

costs of pulling cables, along with a physical infrastructure (conduits, raceways, and duct banks) for maintaining cable integrity. This layer does not add anything to the message frame. It simply converts the digital message received from the data link layer into a string of ones and zeroes represented by a signal on the media. One example is RS-485, where a binary 1 is represented by a Mark, or Off state, and a binary 0 is represented by a Space, or On state. A Mark is a negative voltage between terminals on the generator, while a Space is a positive voltage on those terminals.

Physical Layer Options

There are a number of implementations of the physical layer. Network devices allow a wide range of connectivity options. Some networks are well defined using the OSI model, where cables, bridges, routers, servers, modems, and PCs are easily identified. Sometimes only a few devices are linked together in some kind of pro-

RS-422, and RS-485 for connecting two or more devices together. All three interfaces use data terminal equipment (DTE) and data communication equipment (DCE) terminology (Figure 4-2). The DTE is the component that wants to communicate with another component somewhere else, such as a PC communicating with another PC. The DCE is the component actually doing the communicating, or, performing the functions of the generator and receiver discussed in the standards. A modem is a common example of a DCE.

The interfaces between DTE and DCE can be categorized by mechanical, electrical, functional, and procedural aspects. Mechanical specifications define types of connectors and numbers of pins. Electrical specifications define line voltages and waveforms, as well as failure modes and effects. Functional specifications include timing, data, control and signal grounds, and which pin(s) the functions are to use. The

procedural interface specifies how signals are exchanged.

RS-485 is another serial data transmission method. Officially, it is EIA 485, or “Standard for Electrical Characteristics of Generators and Receivers for Use in Balanced Digital Multipoint Systems” by the Electronics Industry Association (EIA). This standard defines a method for generating ones and zeroes as voltage pulses. Remember, for all the data handling, framing, packeting, routing and addressing performed by the upper layers, it still comes down to pushing ones and zeroes over some physical media.

What is important to know about RS-485 is that it allows multiple receivers and generators, and it specifies cable characteristics in terms of signaling speeds and lengths. A typical cable is a shielded twisted copper pair, which is adequate for the typical sig-

naling rate of 10 million bits per second (Mbps). This standard only defines the electrical characteristics of the waveforms. Note that RS-485 does not specify any media control functions—that is strictly up to the device connected to the generator (usually a chip). RS-485 is generally good for cable lengths up to 2,000 feet.

One example of a simple serial network might be a series of recorders connected over an RS-485 link to a PC that receives data acquired by each recorder. The manufacturer sells a plug-in card that installs in each recorder, with wiring instructions. Each network card is daisy-chained to the others over a series of shielded twisted pair cables that ultimately terminate on a network interface card in the PC. There is no real need to know and understand the network layers in this arrangement, except to understand

the limitations on RS-485 (distance, shielding, data rate, etc.).

By title, the RS-422 standard is TIA/EIA 422 B, “Electrical Characteristics of Balanced Voltage Digital Interface Circuits” by the Telecommunications Industry Association (in association with the EIA). It is similar to RS-485; the main differences being the rise times and voltage characteristics of the waveform. RS-422 generally allows cable lengths up to 1.2 kilometers at up to 100 thousand bits per second (kbps). At 10 million bps (Mbps), cable lengths are limited to around 10 meters (Figure 4-3). In the presence of cable imbalance or high common mode noise levels, cable lengths may be further reduced in order to maintain a desired signaling rate.

RS-232C is perhaps the most common form of serial data exchange. It is officially known as EIA/TIA 232 E, “Interface Between Data Terminal Equipment and Data Circuit-Terminating Equipment Employing Binary Data Interchange,” again by TIA in association with the EIA. The “E” suffix denotes a later version than the common “C” version. What makes this standard different from RS-422 and RS-485 is that it defines the mechanical as well as the electrical interfaces.

RS-232 is good for signal rates up to 20 kbps, at distances up to 50 feet. A zero (space) and a one (mark) are measured in terms of a voltage difference from signal common (+3 V dc = 0, -3 V dc = 1). The most common mechanical interfaces are the D-sub 9 and D-sub 25 connectors.

Interchange circuits (pins) in RS-232 devices fall into four categories: signal common, data circuits (transmitted data, received data), control circuits (i.e., request to send, clear to send, DCE ready, DTE ready), and timing circuits.

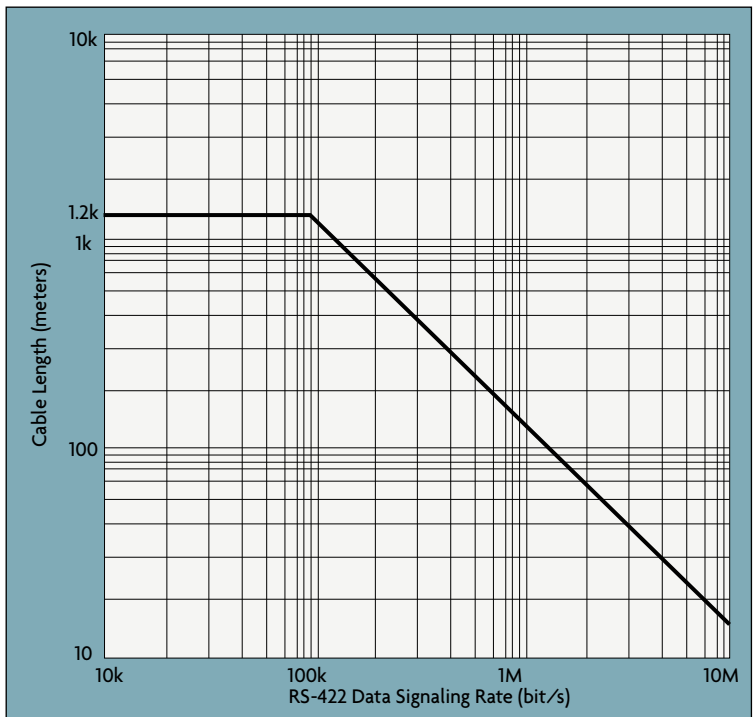

Figure 4-3: Cable Length vs. RS-422 Data Rate

The standards described above all are used in serial communications schemes designed for longer distances. There is one common parallel interface, known as the General Purpose Interface Bus (GPIB), or IEEE-488. Up to 15 devices can be interconnected, usually personal computers and scientific equipment or instruments. It provides a high data signaling rate, up to 1 Mbps, but it is limited in length. The total bus length permitted is 20 meters, with no more than 4 meters between devices.

The IEEE-488 bus is a multi-drop, parallel interface with 24 lines accessed by all devices. The lines are grouped into data lines, handshake lines, bus management lines, and ground lines. Communication is digital, and messages are sent one byte at a time. The connector is a 24-pin connector; devices on the bus use female receptacles while interconnecting cables have mating male plugs. A typical cable will have male and female connectors to allow daisy-chaining between devices.

An example of an IEEE-488 implementation is a measurement system designed to assess the performance of a chemistry sample sink. The sink performs sample conditioning (pressure, flow, and temperature control) and chemical analysis (pH, dissolved oxygen, and conductivity) on water samples. The sink is instrumented with pressure sensors, resistance temperature detectors (RTDs), thermocouples, and reference junctions. A 30-point scanner is used to multiplex data from all of the sensors. The scanner is connected to a desktop or laptop PC using the GPIB interface. Data is acquired, stored, displayed, and reduced using application programs on the PC, efficiently and reliably under IEEE-488.

The media used to implement the physical layer is usually a set of copper wires. Unshielded twisted pair (UTP) cable is the most affordable. It is lightweight, easy to pull, easy to terminate, and uses less cable tray space than shielded twisted pair (STP). However, it is more susceptible to electromagnetic interference (EMI).

STP is heavier and more difficult to manufacture, but it can greatly improve the signaling rate in a given transmission scheme (Figure 4-4).

Fiber optics are being used more often as user applications demand higher and higher bandwidths. The term “bandwidth” technically means the difference between the highest and lowest frequencies of a transmission channel, in hertz (Hz). More commonly, it means the capacity or amount of data that can be sent through a given circuit.

A bandwidth of 100 Mbps is standard using fiber optic cables. When first introduced, fiber was considered

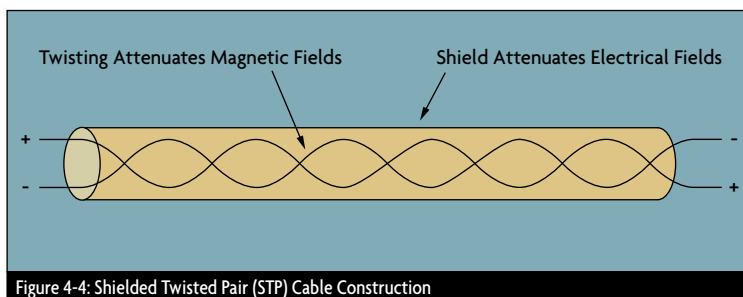

Figure 4-4: Shielded Twisted Pair (STP) Cable Construction

Twisting provides cancellation of magnetically induced fields and currents on a pair of conductors. Magnetic fields arise around other heavy current-carrying conductors and around large electric motors. Various grades of copper cables are available, with Grade 5 being the best and most expensive. Grade 5 copper, appropriate for use in 100-Mbps applications, has more twists per inch than lower grades. More twists per inch means more linear feet of copper wire used to make up a cable run, and more copper means more money.

Shielding provides a means to reflect or absorb electric fields that are present around cables. Shielding comes in a variety of forms from copper braiding or copper meshes to aluminized mylar tape wrapped around each conductor and again around the twisted pair.

only for special applications because it was expensive and difficult to work with. In recent years, the quest for greater bandwidth combined with easier-to-use fiber have made it more common. Tools and training for installing and troubleshooting fiber are readily available.

There are three basic fiber optic cables available: multimode step index, multimode graded index, and single mode. Multimode fibers usually are driven by LEDs at each end of the cable, while single mode fibers usually are driven by lasers. Single mode fibers can achieve much higher bandwidths than multimode fibers, but are thinner (10 microns) and physically weaker than multimode. Equipment costs for transmitting and receiving single mode fiber signals are much higher (at least four times) than for multimode signals.

One distinct advantage of fiber optic cables is noise immunity. Fiber optic cables can be routed indiscriminately through high noise areas with impunity, although fire ratings should be observed. Cables that pass through multiple spaces in a plant should be rated for heating/ventilation/air conditioning (HVAC) plenums where they can withstand

tralized maintenance and configuration control.

• **Token Buses & Rings**

The MAC functions of token rings and buses are similar. ARCnet, developed by the Datapoint Corp. in the '70s, is a token passing protocol that can be implemented in a bus or star topology using coaxial or UTP cables.

ARCnet is available in a 20-Mbps version.

The IBM token ring protocol, standardized via IEEE-802.5, runs at 4 or 16 Mbps. Nodes on the ring connect to a multi-station access unit (MAU), a type of hub. MAUs can be connected together in a main ring, with segments, or lobes, from each MAU connected in a star configuration to devices with network interface cards. The length of the ring is limited to 770 meters and the maximum number of nodes allowed on a ring is 260 using STP cable. STP cable (150 ohm) is used most often, but UTP (100 ohm) cable can be used if passive filtering is provided for speeds up to 16 Mbps. Bridges can be used to connect rings.

Jitter is an interesting problem that can arise on token ring networks, where nodes that are supposed to be synchronized with the master node receive distorted waveforms due to cable attenuation. The result is that each node operates at a slightly different speed. Jitter restricts the number of nodes allowed on the ring (72 at 16 Mbps on UTP). Jitter suppressors are available that can help alleviate this problem.

Repeaters are available for extending the ring. Using phase-locked-loop (PLL) technology, a repeater can extend the main ring an additional 800 feet at 16 Mbps on Category 5 copper UTP.

Using a media converter, or fiber optic transceiver, conversion between copper and single mode or multi-mode fiber is possible, thus extending main ring lengths or lobe lengths up to 1.25 miles.

• **Ethernet, or CSMA/CD**

The most common bus topology in business applications is Ethernet. Ethernet originally was developed by

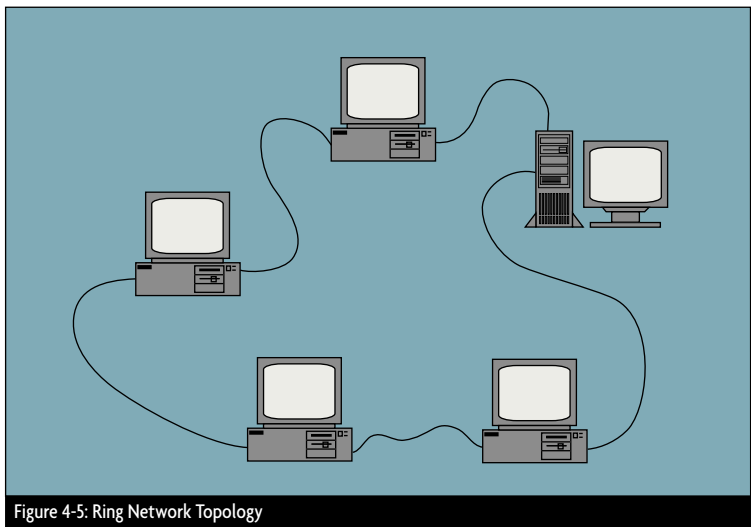

Figure 4-5: Ring Network Topology

fires per National Fire Protection Association (NFPA) requirements.

Network Topologies

The term topology refers to the method used to connect components on a network. The most common topologies are ring, bus, and star topologies (Figures 4-5, 4-6, and 4-7), but they can take on the appearances of each other and still maintain their characteristics. For example, a token ring network segment can be wired in a star configuration, where components are cabled back to a hub where the ring is “inside” the hub. This allows a common wiring closet for a given building or area with home-run cable pulls for each component. A hub offers the advantages of cen-

A “token” is passed around the bus or ring. Whichever node has the token is allowed to communicate on the media. ARCnet runs at 2.5 Mbps, at the following lengths:

- 400 feet with 10 nodes using UTP;
- 2,000 feet with a practical limit of up to 100 nodes using RG-62 coaxial cable in a coaxial star configuration (using a hub or hubs); and
- 1,000 feet with 10 nodes per 1,000 foot segment using RG-62 coaxial cable.

ARCnet uses active and passive hubs in the star configuration, with network cards on the devices that have switches for setting node numbers. The lowest numbered node is the master controller, giving permission to communicate to each node

the Xerox Corp., and later improved in association with Digital Equipment Corp. (DEC) and Intel. IEEE-802.3, based on the Ethernet standard, specifies a Carrier Sense Multiple Access with Collision Detection (CSMA/CD) media access control protocol. This network standard provides functionality at the first two OSI network layers—the physical and data link layers.

This MAC protocol allows independent transmission by all nodes on a network segment. A node sends messages down the segment with data, addressing, and control bits. All other nodes “see” the message, but only the node with the destination address will acknowledge and receive the message. When the sending node is using the segment (transmitting), all other nodes with messages to send “hear” the carrier and do not send. This type of protocol is known as “listen before send.” If two nodes attempt to send at the same time, a collision is detected, and both nodes stop sending, wait a small, random amount of time, and resend. Where there is a lot of net-

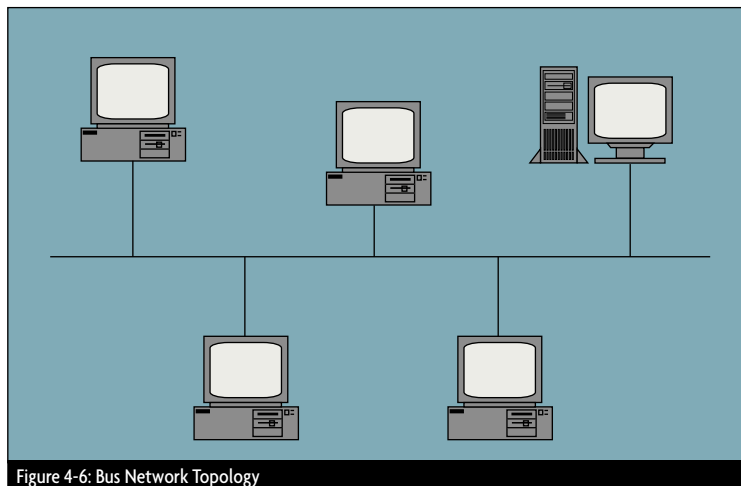

Figure 4-6: Bus Network Topology

work traffic, many collisions can occur and overload the system.

The Ethernet CSMA/CD standard can be implemented in five different ways:

- 10Base5—standard “thick” coaxial cable;
- 10Base2—“thin” coaxial cable;
- 10BaseT—UTP;
- 100BaseT—UTP; and
- 10BaseFL or FOIRL—fiber optics.

The XBaseY nomenclature is interpreted as follows: X = the sig-

naling rate in Mbps, and Y = some indication of the media type. The “Base” portion of the term means the signal uses the cable in a baseband scheme (as opposed to a broadband, multi-frequency, multi-channel modulating scheme).

10Base5 is a standard Ethernet implementation that uses RG-58 coaxial cable segments up to 500 meters long. Transceivers are clamped on to the segment, with a minimum distance between transceivers of 2.5 meters. A transceiver cable (or spur) connects the transceiver to the network node or device; this cable can be up to 50 meters in length. The maximum number of transceivers allowed is 100 per segment, and both ends of each segment are terminated with a 50-ohm resistor. Transceivers can be connected to hubs for fanning out to network nodes.

The 10Base2 “ThinNet” does not use a long coaxial segment with transceivers. Instead, modular repeaters are used with ThinNet modules in a star configuration. Thin coaxial cable is terminated with “T” connectors on network nodes, with multiple nodes connected in series on a segment,

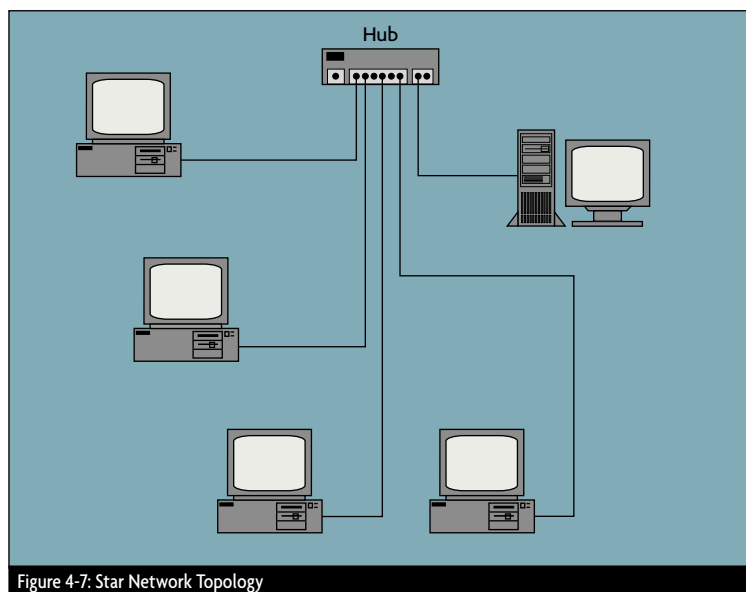

Figure 4-7: Star Network Topology

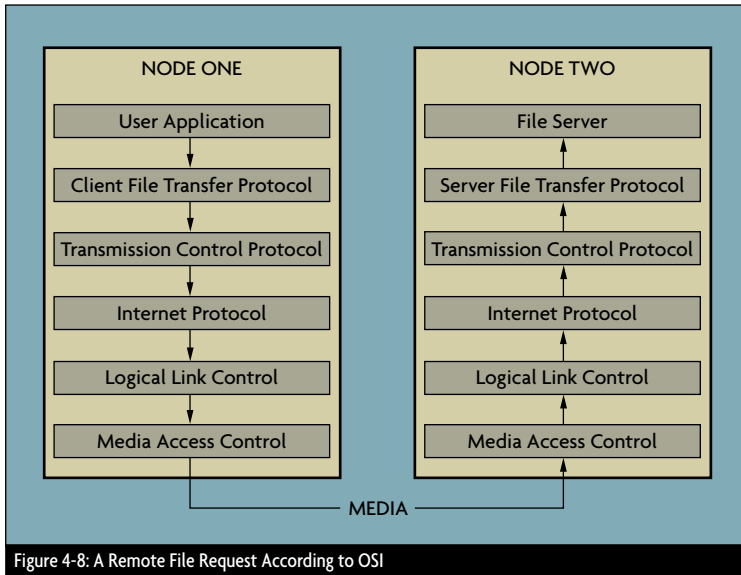

Figure 4-8: A Remote File Request According to OSI

with one end of the cable home-run back to the repeater. The maximum length of a series segment is 185 meters, with a minimum distance between nodes (T-connectors) of 0.5 meters. No more than 30 nodes are allowed on a segment. 50-ohm terminators are required at each end of a segment.

The 10BaseT implementation uses UTP cable, with best results from Category 5 copper. Nodes are connected to a hub in a star configuration. The maximum length of one segment is 100 meters.

The 10BaseFL implementation uses 50, 62.5, or 100-micron multimode fiber optic cable. Fiber transceivers are available for connecting to network interface cards that do not support fiber.

Repeaters can be used to connect 10Base5 segments together up to 2,500 meters, and components and smaller networks can be linked together with interface devices to join the various media types into a larger network.

The IEEE-802.3 standard covers several CSMA/CD implementations,

with lengths up to 925, 2,500, and 3,600 meters. The number of nodes allowed follows the hardware and performance requirements of the network operating system. More nodes and higher traffic mean more potential for collisions. Network performance might drop when you need it the most, such as during a plant transient when data flow and control element actuations are high.

Ethernet or CSMA/CD is established for 1, 10 and 100 Mbps, with 10 Mbps currently being the most com-

mon. Some vendors are offering “fast” Ethernet at 100 Mbps, compatible with existing 10 Mbps implementations. 100BaseT is essentially 10BaseT, only 10 times faster. They both use the same MAC layer. At higher speeds, implementations should account for round-trip delays for collisions.

Finally, a wireless Ethernet implementation is available. It supports data rates up to 3 Mbps through open spaces up to 3,000 feet and indoors from 200 to 600 feet, and line of site is not required indoors. Wireless repeaters and bridges are available to link cells together.

Decisions regarding local area network (LAN) topologies and MAC protocols can affect the way a network is managed for years to come. A new facility can be wired with state-of-the-art network components and premise wiring devices, but the network administrator or plant engineer is usually faced with an existing infrastructure, where options are constrained by installed media. For example, an old, abandoned 4-20 mA dc current loop STP cable can always be used to implement 10BaseT Ethernet and save considerable project funds. Or, a new fiber optic cable can be purchased with multimode fibers for this

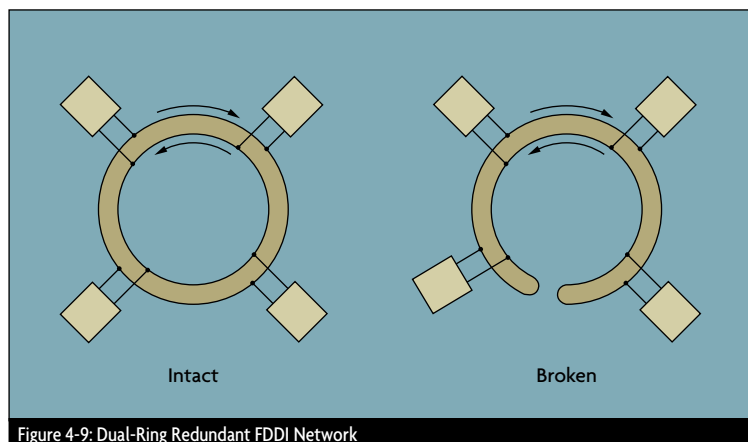

Figure 4-9: Dual-Ring Redundant FDDI Network

year's low bandwidth project and still have spare, single-mode fibers for future, high bandwidth applications.

Token passing and CSMA/CD protocols make interesting comparisons. Token passing offers a predictable access window with consistent performance on large, busy networks, but nodes need to wait for the token and large rings can result in significant delays. CSMA/CD allows a node to transmit immediately when the network is quiet, but performance can be unpredictable and depends on the probability of collisions.

Upgradeability and growth are two areas that should be considered for each new segment or modification to a given segment. The challenge is to keep an eye on network demands as new applications come along, and select the right amount of bandwidth and upgradeability for the dollar.

• Moving Up the Layers

So far, the physical layer has been described, with implied functions at the data link and network layers. Two devices can communicate by way of a simple RS-485 link or they can be part of a larger LAN with complex media access controls.

The data link's only function is to pass data from one node to the next. The data link layer can connect two nodes or devices with a "bridge." Early bridges only connected two segments of a network with the same protocol (such as CSMA/CD or token passing). Smart bridges are available now that can connect differing protocols, with selective forwarding of data packets. Various levels of data link performance exist depending on the size of the network (wide vs. local area network; WAN vs. LAN) and the protocol/media selections.

The network layer routes incoming

data for another node onto an appropriate outbound path. The physical device that performs this function is naturally called a router. Since bits still need to be pushed down some physical media, a router inherently performs the physical and data link functions in order to go up and down the OSI model, although routers are not sensitive to the data link and physical layer details, allow-

largest and most popular provider of network operating system (NOS) software. Novell provides CSMA/CD and token passing options.

The TCP and SPX protocols operate at the transport layer, and the IP and IPX layers operate at the network layer. Thus, routers send and receive packets between nodes with "IP addresses." The downside is that routers can only exchange data

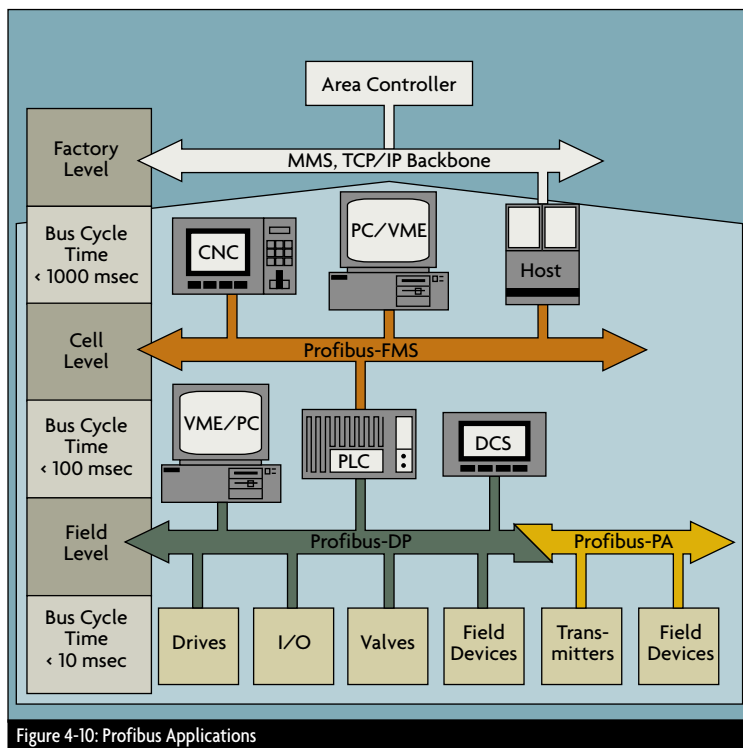

Figure 4-10: Profibus Applications

ing them to connect different types of networks. A router takes an incoming packet, looks at the destination address, determines the best route, and provides the required addressing. One common implementation of this function is Transmission Control Protocol/Internet Protocol (TCP/IP). On Novell networks, this function is called Sequenced Packet Exchange/Internetwork Packet Exchange (SPX/IPX). Novell, Inc. is perhaps the

largest and most popular provider of network operating system (NOS) software.

Gateways operate at the network layer or above; they are used to connect dissimilar networks or systems via network protocol conversion.

The term "stack" refers to pieces of the OSI model that are bundled together. In client-server models, the TCP/IP software is sometimes referred to as a stack.

For example, on a PC with a net-

work interface card, a word processor program (application), operating system (Windows NT), and redirector are at work (redirectors intercept network application I/O requests alongside a device's operating system). In this example (Figure 4-8), a user wants to open a file stored on a remote file server on another network by clicking on the G drive in the list of available drives (including the local A, B, and C drives). The redirector sees the I/O request, recognizes its external

it is processed, and the reply is sent back essentially the same way.

• **Backbones**

In larger enterprises, some sort of information backbone, or data highway, allows high speed, high quality internetworking with good reliability. Backbones connect LANs, WANs and other forms of network segments together in one large network. The decision to build a backbone depends on the present and future needs of the enterprise. But once it is imple-

the primary ring, with some or all attached to the secondary ring. The idea is that if one ring breaks, the other automatically picks up the load. If both rings break at the same point, they automatically join together in one long ring (Figure 4-9).

FDDI hubs are available that bring together various FDDI devices, LANs, and Ethernet devices over single-mode or multimode fiber or copper. FDDI is a good choice for linking buildings together on a campus or industrial site.

Another implementation of an enterprise backbone, either stand-alone for one particular link or in conjunction with other technologies, is microwave technology. Operating at frequencies between 2 and 40 gigahertz (GHz), transmitters and receivers use long, line-of-site transmission paths. The economics are reasonable when compared with trenching and laying cable. The higher the tower, the longer the link (on the order tens of miles). Data rates are typically 1.544 Mbps. Leasing telephone lines is usually the alternative to microwave.

Satellite technology is just beginning to come into play for industrial and commercial network implementations. Remote transmitters for stationary platforms (such as well heads) or mobile platforms (as in the trucking industry) are being used to transmit real-time data via uplinks to a communications satellite and back down to ground stations. Telephone companies can provide switched services between the satellite system and a given enterprise network.

Fieldbus & Device Networks

While the network technologies described so far are typical for business information systems, they are

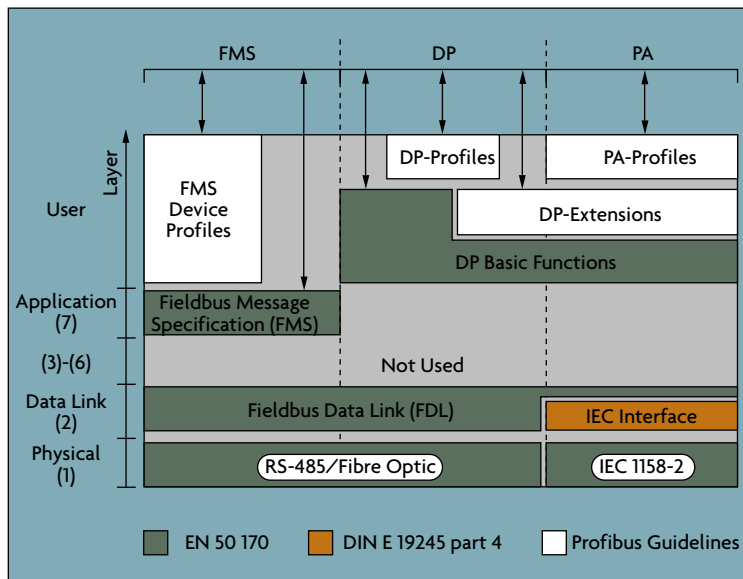

Figure 4-11: Protocol Architecture of Profibus

location, and sends it to the network interface card. On its way, the request goes through the TCP/IP stack where addressing and protocols at the transport and network layers are handled. The network interface card receives the request and holds it until it can get on the network and pass it on (push the bits) to the next node. The request is sent from node to node, using appropriate IP addresses and protocols until it gets to the server, where

mented, growth becomes less painful. One common backbone is the Fiber Distributed Data Interface, or FDDI standard. This backbone is also available in a copper version (CDDI).

FDDI is considered an implementation of a "metropolitan" LAN, or MAN. It is a dual-ring topology that can span up to 200 kilometers at 100 Mbps. It is commonly used to connect LANs together where higher bandwidths are required. Two rings of fiber carry data. All nodes attach to at least

converging with industrial instrumentation and control systems. Industrial plants have used information technology (IT) for years, but with open IT standards, faster computers, emerging software, and demand for integrated information by all segments of an industrial enterprise (accounting, engineering, operations, maintenance, and management), industrial networks are merging right into enterprise-wide IT solutions.

PLCs and distributed control systems (DCSs) are offering Ethernet/TCP/IP connectivity so that real-time information on plant processes is readily accessible by any workstation on the network (LAN or WAN), in a client-server relationship. A plant manager can watch a graphic display of plant operations in one window while scanning accounting data in another. Object Linking and Embedding (OLE) and Dynamic Data Exchange (DDE) can merge data streams, such as unit cost (from accounting) and production totals (from the plant floor) in one spreadsheet. Internet and intranet browsers running Java or HTML applications access data acquisition and control systems using standard LAN/WAN technologies.

Meanwhile, on plant and factory floors, industry has developed its own range of fieldbus or device-level networks for linking control devices with increasingly intelligent instrumentation. As the terms have evolved over the past several years, device networks typically embrace those optimized for discrete manufacturing automation, while fieldbus connotes more process-oriented instrument networks. On the discrete side, the emphasis is on high-speed transmission of typical-

ly smaller information packets. Process fieldbuses, on the other hand, sacrifice speed for more secure transmission of larger information packets. Intrinsically safe capabilities also are prerequisite for many process applications.

An exhaustive comparison of the 20-some device and fieldbus protocols currently available is beyond the scope of this volume. However, an examination of two leading alternatives, the Profibus family of automation networks and the Foundation process automation protocol, illustrates the essential concepts of both types of networks.

• **The Profibus Family**

Profibus is a fieldbus and device network technology used primarily in Europe, but gaining worldwide acceptance. The Profibus family follows an open network standard (EN 50 170) with hundreds of vendors supporting a common, interchangeable interface and protocol.

• **Profibus PA**—Process Automation. Allows sensors and actuators to be connected on one common bus line, even in intrinsically safe areas.

• **Profibus DP**—Factory Automation. Optimized for high speed and inexpensive connectivity (plug and play). Designed for communication between automation control systems and distributed I/O at the device level.

• **Profibus FMS**—Automation for General Purposes. Designed for a large number of applications and communications at the cell level.

Profibus is basically a serial bus system with which digital controllers can be networked together with master and slave devices over a pair of wires. Masters, or active stations, control the data communication on the bus. They can send messages without an external request by holding bus access rights by way of a token. Slaves, or passive stations, are peripheral devices that may include input/output (I/O) modules, valves, drives, and

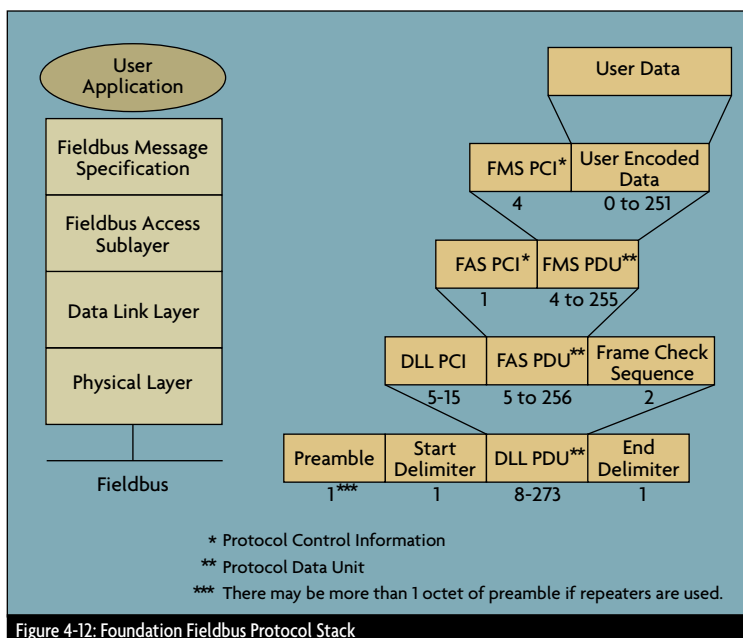

Figure 4-12: Foundation Fieldbus Protocol Stack

transmitters. Slaves do not have bus access rights; they can only acknowledge received messages or send messages when the master requests one.

The Profibus protocol varies with each member of the family (Figure 4-11).

Profibus DP uses the physical and data link layers (1 and 2), coupled to a user interface, for fast and efficient data transmission. Layers 3 through 7 are not defined. A Direct Data Link Mapper (DDLM) provides access between the user interface

(FMS) and a Lower Layer Interface (LLI). FMS runs the application protocol as well as supporting communication services. The LLI implements communications and provides device-independent access to the Fieldbus Data Link (FDL) at layer 2. Layer 1 is implemented again in RS-485 or fiber optics.

Profibus PA is an extension of the Profibus DP protocol for data transmission. Layer 1 (physical) in this standard uses IEC 1158-2, which pro-

(+9 mA dc to -9 mA dc in the 1158-2 case) over an elevated steady-state voltage or current. A high-to-low transition is a one, and a low-to-high transition is a zero. Thus, every bit period has a transition in it, allowing the receiver to synchronize easily with the transmitter. One disadvantage is that it requires twice the bandwidth as straight binary encoding.

Profibus DP and Profibus PA can be integrated via a segment coupler. And because Profibus DP and Profibus FMS use the same transmission technology and a uniform bus access protocol, they can be operated simultaneously on the same cable.

• **Foundation Fieldbus**

The Fieldbus Foundation is a worldwide consortium of manufacturers and industry groups that have designed and manufactured another open fieldbus technology called Foundation. Software and hardware specifications have been written by design and marketing teams, and many products are becoming available that conform to this standard across many different vendors.

The Foundation protocol (Figure 4-12) uses layers 1, 2, and 7 (physical, data link, and application layers). Layers 2 and 7 are considered bundled together in a communication stack.

Foundation and Profibus look similar at first. On the physical layer, the main differences are in signaling methods. Foundation offers IEC 1158-2 signaling, like Profibus.

Foundation also offers a 31.25-kbps option, as well as 1.0 and 2.5-Mbps options. The 31.25-kbps version uses a Manchester encoding scheme (± 10 mA dc into 150 ohm load) that can use existing 4-20 mA twisted pair wiring. With an intrinsically safe

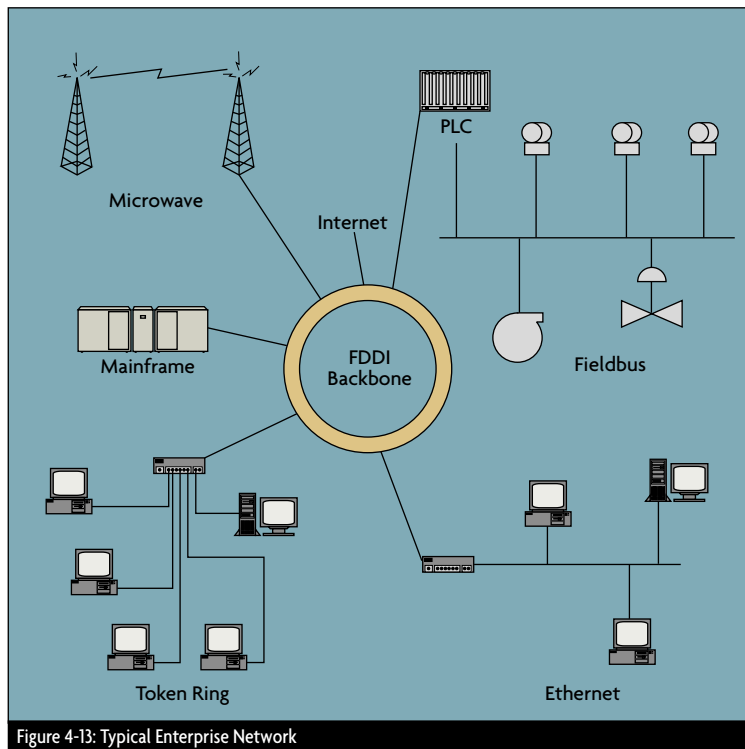

Figure 4-13: Typical Enterprise Network

and the data link layer. Application functions are defined in the user interface. The physical layer is defined via the RS-485 or fiber optic transmission technologies.

Profibus FMS defines the physical, data link, and application layers. Layers 3 through 6 are not defined. The application layer combines the Fieldbus Message Specification

vides intrinsic safety and “power on the bus” for field devices. 1158-2 modulates a steady-state 10 mA dc “basic current” (the bus power) by Manchester encoding a ± 9 mA dc signal on top of the basic current.

Manchester encoding refers to a signaling technique that produces binary ones and zeroes by transitioning between high and low signals

(IS) barrier, the 31.25-kbps option supports intrinsic safety. The dc supply voltage ranges from 9 to 32 volts, but may be restricted to the barrier rating. Stubs or spurs are allowed, from 1 meter to 120 meters depending on the number of devices on the bus.

The 1.0 and 2.5-Mbps options both offer voltage mode signaling. The 1.0-Mbps option also allows current mode signaling. The voltage mode method delivers ± 60 mA dc into a 75-Ohm equivalent load, while the current mode signaling method modulates the fieldbus signal on top of a 16-kHz ac power signal.

The Foundation communication stack is comprised of layers 2 and 7 in the OSI model. Layers 3 through 6 are not used. The Data Link Layer, or DLL, controls message transmission on the bus through a Link Active Scheduler (LAS). Link Masters and Bridges are used to control and extend the bus.

The Fieldbus Access Sublayer (FAS) works with the Fieldbus Message Specification (FMS) to form an application layer, just underneath the user application. The FAS services are

described via Virtual Communication Relationships (VCRs). The VCR is like a speed-dial feature on a telephone, used for communicating quickly and easily to another fieldbus device. Three VCR types, Client/Server, Report Distribution, and Publisher/Subscriber are used for operator messages, event notification and trend reports, and data publishing, respectively.

The Fieldbus Message Specification (FMS) communicates via data objects and function blocks over the bus. FMS can only use the client/server VCR type.

User applications in the Fieldbus protocol use standardized function blocks for I/O engineering unit conversion, and common functions like PID control. 

References and Further Reading

- *The Data Acquisition Systems Handbook*, Omega Press LLC, 1997.
- *New Horizons in Data Acquisition and Computer Interfaces*, Omega Press LLC, 1997.
- *Omega® Universal Guide to Data Acquisition and Computer Interfaces*, Omega Press LLC, 1997.
- *Business Data Communications*, Fourth Edition, D. A. Stamper, Benjamin/Cummings, 1994.
- *Computer Networks*, Second Edition, A. S. Tanenbaum, Prentice Hall, 1988.
- *Data Communications - Video and Workbook*, by Industrial Training Corp. for ISA, 1993.
- *Data Communications, Computer Networks and Open Systems*, Fourth Edition, F. Halsall, Addison-Wesley, 1996.
- *Distributed Systems - Concepts and Design*, Second Edition, G. Coulouris, J. Dollimore, and T. Kindberg, Addison-Wesley, 1994.
- *Guide to Networking and Internetworking Terms*, P. Simoneau, American Research Group, 1994.
- *How Networks Work*, F. J. Derfler, Jr., and L. Freed, Ziff-Davis Press, 1993.
- *Technical Overview: Foundation Fieldbus*, Fieldbus Foundation, 1996.

- Plug-in Cards
- Standalone Components
- Communication Devices

Data Acquisition Hardware

Previous chapters of this volume have acquainted you with the technology of how input/output (I/O) signals are generated, conditioned, linearized, and transmitted to a host computer or controlling system. In this chapter, we will look at the different kinds of data acquisition hardware that are available to help you perform all of these functions.

Before starting, a brief good news/bad news observation: The good news is that modern micro-computer technology has made it relatively simple to install, configure, and start up a high-performance data acquisition system. Experienced users will be happy to know that many of the problems encountered a few years ago are gone. New users will never realize how difficult it once was to bring up a data acquisition system. The bad news is that these same technology advances have made it even more difficult than ever to select among the many options. The hardware decisions facing a user today require a great deal of study, analysis, and consideration. Every system will work, but some are better than others for each particular application.

Some things to consider:

Connect to the Internet or an intranet? Today, users can obtain real-time data over the Internet or an in-house intranet, using a standard browser, an Ethernet connection or modem, and a PC or network computer (NC). A network computer has no moving disk to store programs. Instead, it downloads various software packages in the form of

“applets” to the NC when needed. This means that your real-time data can be viewed by anyone in the world (if they have the proper access). The argument for using NCs is powerful. It could affect your choice of hardware.

What PC interface? Virtually all objections to using PCs on the plant floor have been answered, and PCs



Commercially available data acquisition systems and components come in a wide variety of configurations and form factors.

are now performing everything from real-time control to high-speed data acquisition. One major issue to be considered is the various bus architectures available for PCs. While we will discuss the various computer buses below, you may want to explore this topic in more detail to determine the effect it may have in your application, now and in the future.

Is there software support? Most data acquisition hardware is compatible with most popular industrial software, or it comes with a software package of its own. Free or not, it is a good idea to investigate the software

and hardware's capabilities. (For more details on software selection criteria, see Chapter 6.)

Selecting a System

It is possible to select a wide range of different products and configurations that will acquire and process data equally well. These range from field-mounted individual devices—such as DIN-rail signal conditioners or smart transmitters—to plug-in data acquisition systems that can be installed in a PC.

Virtually all these data acquisition devices and systems have the same basic specifications and options on their data sheets:

- **Signal conditioning:** The signal from any sensor must be converted from its analog form into a digital signal that the host computer or controller can understand. This can be done by a transducer or transmitter in the field, a local signal conditioner, or—if close enough—by the analog-to-digital (A/D) converter on a data acquisition board. In addition, signals from nonlinear sensors, such as differential pressure flowmeters and thermocouples, must be linearized. If the environment is particularly noisy, these conversions should be done as close to the sensor as possible.
- **Number of analog input channels:** Analog inputs usually are specified as single-ended or differential input channels. Single-ended (SE) channels all reference the same ground point. Differential inputs (DE) have different reference points for each input, and therefore need two channels. In general, SE channels are appropriate

when the input signals are greater than 1 V, the signal source is no more than 15 feet away, and all inputs share a common reference. DE inputs have better noise immunity and help prevent ground loops.

- **Sampling rate:** This determines how fast an analog signal is converted to digital. In general, select a sampling rate that is twice as fast as you need. The operating software of most PC systems causes skew to occur. Skew can approach or even exceed the sampling interval. When this happens, patterns in the data may no longer be accurate or reliable.

- **Resolution:** This determines the smallest value change the system can detect. Most systems have 12 or 16-bit resolution; a 12-bit system resolves 1 part in 4,096, while a 16-bit system resolves 1 part in 65,536. The resolution in engineering units is determined by dividing the measurement span by 4,096 (or 65,536). For example, if you are measuring a voltage signal of 0-1,000 V with 16-bit resolution, the smallest change the system can see is ± 0.2 V (or ± 0.015 V).

- **Accuracy:** This is a function of many variables in the system, including A/D nonlinearity, amplifier nonlinearity, gain and offset errors, drift, and noise. (See further discussion in the “High-Accuracy Data Acquisition” section that follows.)

- **Analog inputs:** Typical voltage inputs are 0-1 V, 0-10 V, ± 50 mV, ± 100 mV, ± 0.5 V, ± 5 V, and ± 10 V. Other inputs include 0-20 mA, 4-20 mA, frequency, and resistance. Most of the big four process control measurements—flow, temperature, pressure, and level—fit one or more of these input ranges. Most data acquisition products have selectable or programmable analog inputs that accept the signal, and send it to a 12-

or 16-bit A/D converter.

- **Analog outputs:** While not strictly part of data acquisition, many data acquisition products offer analog outputs on the same board. In almost all cases, a data acquisition board has either 2 or 4 outputs. If more are needed, a dedicated analog output board may be required.

- **Digital I/O:** Most digital I/O can be selected for either input or output. In most cases, it is possible to configure a data acquisition board with digital inputs, outputs, or both in any combination. Boards that claim to be “multifunctional” have the most digital I/O.

grated circuits (ASICs) combine the functions of several components into one. They also eliminate the connections between those individual devices, increasing speed, improving accuracy, and reducing exposure to noise.

- **Reduced board size:** With today’s SMT and ASIC technology, many data acquisition boards are being made in a smaller size (form factor). Once again, reducing the size and number of traces boosts speed and minimizes noise.

- **Isolated inputs:** Input isolation protects the board from damage or disruption from an abnormal signal

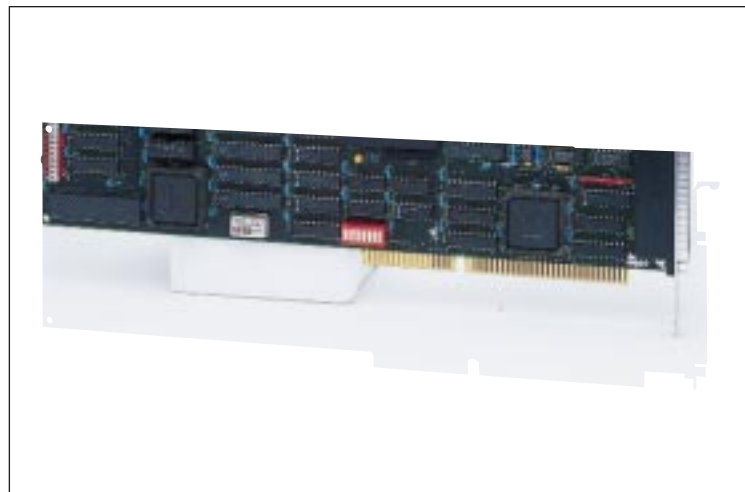

Typical ISA-bus data acquisition board plugs into a standard PC and offers a variety of speed, resolution, and other feature options.

In addition to comparing basic specs, examine how the product is designed and built. Accuracy is often dependent upon the amount of noise picked up by the system. Modern data acquisition products minimize this problem in several ways:

- **Surface mount technology (SMT):** Using SMT shortens the length of traces on the board, which improves electrical noise resistance.

- **ASICs:** Application specific inte-

or noise on the input line.

Finally, you have to decide what type of data acquisition system to use. There are two major choices:

- **Plug-in data acquisition cards:** These plug directly into the chassis of your computer. Signals from sensors or signal conditioners are wired to the computer and connected to the data acquisition board.

- **Standalone systems:** Self-contained I/O systems acquire data in

the field, and send it to the computer via a network or communications method of some kind.

Let's look at both types.

Plug-in Cards

Data acquisition cards that plug into the chassis of a desktop PC, a PC-compatible industrial computer, or an Apple Macintosh computer have made measurement and control extremely economical for the typical lab or industrial user.

A plug-in data acquisition card with 16 analog input channels in the

were expensive to buy, install, maintain, and update.

Today, a PC has the same amount of computing power as yesterday's RISC workstations. Desktop and panel-mounted industrial PCs are available with up to 300-MHz Pentium II processors, enormous amounts of memory, fast disk drives, high-speed networking capability, and powerful operating systems. Mac-based systems have similar capabilities.

Previously, hardware and software for high-end systems were not interchangeable among products from

tings, changing IRQ levels, writing software drivers, and performing hardware calibration.

The trend today is toward plug-and-play systems that configure, install, and calibrate themselves. Plug-and-play software selects and assigns system resources automatically.

Many modern data acquisition boards do not require periodic calibration. Those that do often come with autocalibration functions built in.

Plug-in boards offer a great deal of software compatibility, virtually eliminating the need to write drivers or special software to interface them to a system. If you already have software, check to be sure that the data acquisition hardware you are considering is compatible with your system. You can also check with your software supplier to see what data acquisition boards it supports.

A typical plug-in data acquisition board offers these features:

- Analog inputs: 8 DE or 16 SE;
- Resolution: 12- or 16-bit;
- Input range: mV and V;
- Sampling rate: 30,000-330,000 samples/second;
- Analog outputs: 2;
- Digital I/O: 8-16; and
- Base price: \$199 to \$1,200.

There are hundreds of data acquisition board configurations available for PCs and Macs. Many other boards are available with more inputs, higher resolution, and faster scanning speeds. Now, let's look at some of the higher performance boards.

• High-Speed Data Acquisition

A typical plug-in data acquisition card has a sampling rate of 30,000 to 250,000 samples/second. A high-speed data acquisition card, on the other hand, operates at 330,000 to 20 million samples/second. Applications

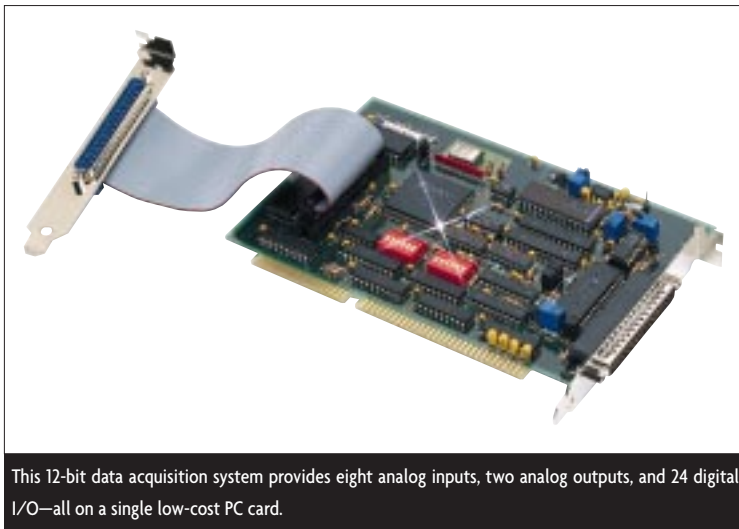

This 12-bit data acquisition system provides eight analog inputs, two analog outputs, and 24 digital I/O—all on a single low-cost PC card.

\$1,000 to \$2,000 price range represents a cost of \$62.50 to \$125.00 per measurement point. This compares to \$350 per point (or more) for a conventional "front-end" or communications-based system.

In the past, high-speed data acquisition systems required expensive, high-end computer platforms such as VAX/VMS minicomputers or Unix RISC workstations to handle large amounts of real-time data and have enough computing power left over to perform control and operator interface functions. Such systems

were expensive to buy, install, maintain, and update. Conversely, plug-in data acquisition boards for PCs, compatibles, and Macs are plentiful, relatively inexpensive, and compatible with each other.

Once, setting up a PC-based data acquisition system was very difficult. Hardware and software were primitive, so installation and configuration required setting jumpers and DIP switches, allocating operating system resources, changing config.sys set-

for such high sampling speeds include wind tunnel testing, auto crash testing, video processing, ultrasonic imaging, and waveform analysis.

At such speeds, the data acquisition card must be able to communicate with its computer via direct memory access (DMA). This allows the card to transfer large quantities of data directly to the computer's memory. In some cases, the card may have dual-channel DMA.

A high-speed data acquisition board often has a considerable amount of first-in-first-out (FIFO) memory. Typically, a high-speed data acquisition board can store 64,000 samples. Some can store more than a million samples, either on the board or by using additional memory on daughter boards.

In most cases, the board does not attempt to acquire 20 million samples every second, because it would soon overflow on-board memory, host computer memory, and disk space. Instead, the board waits for an external trigger signal that says an "event" is occurring, and then it begins to acquire data at high sampling rates. Trigger sources can be analog or digital inputs.

A "typical" high speed data acquisition board—above 330,000 samples/second—has these features:

- Analog inputs: 8 DE or 16 SE;
- Resolution: 12-bit;
- Input range: mV and V;
- Sampling rate: 330,000 to 1,000,000 samples/second;
- Analog outputs: 2;
- Digital I/O: 8; and
- Base price: \$595 to \$2,399.

Often, as speed increases resolution drops to 12-bit. Of course, 14-bit and higher resolutions are available in high speed data acquisition boards at a cost.

One ultra high-speed data acquisition board for radar, ultrasonic, seismic, and related applications acquires data at sample rates up to 500 million samples/sec. Using interleave techniques, rates of up to 1 billion samples/second may be achieved. Boards are available for PC and VME-based systems.

For applications that require high speed data acquisition, plug-in boards that operate at 330,000 to 1,000,000 samples per second are readily available at reasonable prices. The only sacrifice may be in accuracy and resolution.

• **High-Accuracy Data Acquisition**

For most applications, plug-in data acquisition boards with standard 12- or 16-bit resolution are adequate. Some applications, however, require greater accuracy and resolution. Higher resolution means an A/D converter with more bits. Each bit-size increase means that the computer can resolve twice as much data: for example, a 16-bit data acquisition

board can resolve to 1 part in 65,536; increasing to 18 bits quadruples this to 1 part in 262,144.

Data acquisition boards are available with resolutions of 18 bits, 20 bits, and higher. At the higher resolution, much smaller voltage changes can be identified. With a voltage signal of 0-1,000 V, the smallest change the system can see with a 20-bit A/D converter is ±0.0038 V (compared to ±0.015 at 16 bits).

Accuracy also is affected by many other variables. Some of the specifications to consider are:

- **Code width:** This is the smallest voltage an A/D converter can detect. It is a function of resolution, range and gain:

$$\text{code width} = \frac{\text{range}}{\text{gain} \times \text{resolution}}$$

For example, a 12-bit data acquisition board with a range of 20 V and a gain of 100 can detect a 48.8 microvolt μV change in signal (0.0000488 = 20/(100 x 4,096)). A 16-bit data acquisition



Designed to use external signal conditioning cards and a notebook computer, this unique data acquisition system provides a good mix of portability, flexibility, and economy.

sition board detects a 0.030 μV change, and so on. It is a common misconception that accuracy is the same as code width.

- **Settling time:** This is the time required by the programmable gain amplifier (PGA) to respond to the input signal. Most data acquisition boards use a multiplexer to switch signals to the PGA. If data is sampled faster than the PGA can respond, errors will occur. For maximum accuracy, select a data acquisition board with a PGA that can respond to the sampling rate needed.

- **A/D conversion time:** This is the time required by the A/D converter for each sample. A high precision

The file can be downloaded directly into your computer.

Perhaps the most important consideration is that high speed and high accuracy are often mutually exclusive. To obtain maximum accuracy, speed must be sacrificed. This is because:

- Accurate A/D converters operate more slowly than low-precision devices.
- Data acquisition components must have adequate time to settle and convert to obtain the accuracy they are capable of providing.
- Sampling interval may need to be increased to eliminate software skew.

by adding one or more functions, such as high input isolation, timer interface, or specialty software.

- **Thermocouple and RTD input:** These boards permit direct connection of field wiring from temperature sensors without additional external signal conditioning. All necessary linearization, signal conditioning, and noise filtering are done on the data acquisition board itself. Multi-purpose temperature boards usually also accept inputs from strain gages or similar low-level mV signals. Boards also are available to accept thermocouples only (or RTDs only). These boards accept all common thermocouple types, plus mV and voltage signals. A typical board will linearize the thermocouple signal and compute the cold junction compensation. Options include automatic calibration, averaging, and voltage-to-frequency (V/F) sampling to reduce noise.

- **Sensor direct-connect:** Similar to the thermocouple and RTD cards, direct-connect cards allow field-wired sensors to connect directly to the data acquisition board. Sometimes called universal sensor input boards, they accept raw, unconditioned signals from thermocouples, RTDs, thermistors, strain gages, and linear variable displacement transducers (LVDTs), as well as resistance, variable reluctance, frequency, and weight sensors. When using such a board, take care to minimize the length of sensor field wires, because the low-power signals are susceptible to electrical noise.

- **Load cell interface:** This type of data acquisition board performs a dual function. First, it inputs field wiring signals from load cells and strain gages. All signal conditioning, filtering, and data conversions are

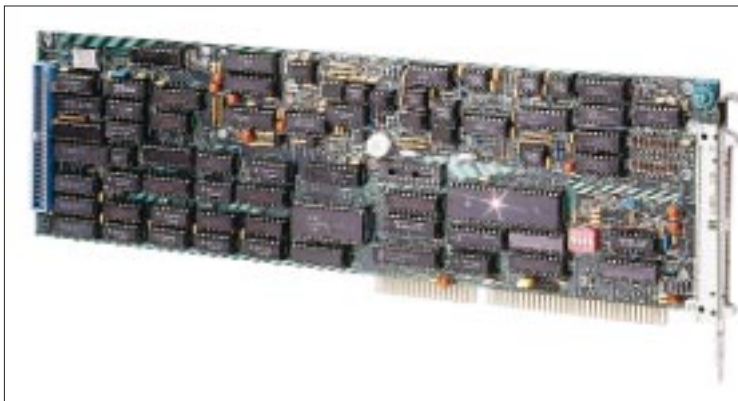

High-speed data acquisition boards can exceed one million samples per second for applications such as transient recording and vibration analysis.

A/D converter might require 2.5 ms, making the maximum sampling rate a fairly slow 400 Hz.

- **Computing accuracy:** It is possible to calculate the theoretical accuracy of any data acquisition board, but the computation is relatively complex, taking into account a dozen board performance parameters. *I&CS* magazine offers the procedure as an Excel worksheet, which can be found on the Internet at: www.chiltonco/ics/calcxem.xls.

- A 20-bit digital value requires 3 bytes of information, 50% more than a 12- or 16-bit value, so it takes 50% more time just to move this data from point to point in the system.

• Specialty Data Acquisition Boards

A wide variety of specialty data acquisition boards also are available. In some cases, these are standard data acquisition boards that have been modified to fit a specific application

done on the board. Second, it supplies the excitation voltage needed by 6-wire, 350-ohm load cells and strain gages. With optional software, the board can make a PC into a high-speed check weigher, load scale, or truck scale.

- **Sample-and-hold (S/H):** Available as an option on some data acquisition boards or as an accessory, the sample-and-hold function allows a number of channels to be sampled virtually simultaneously, while still allowing the A/D converter to be shared among multiple channels. The S/H function “holds” the data until its buffer is emptied and the data is sent to computer memory. In some cases, the simultaneous S/H function is activated by a trigger. When added as an external accessory, the S/H board essentially acts as a front-end to a plug-in data acquisition board, and minimizes skew problems.

• Bus Architecture Options

Plug-in data acquisition cards are designed primarily for two lines of computers: PCs and compatibles, and the Apple Macintosh. Among these, several types of bus architectures are available. Selecting the proper bus architecture is important—the wrong choice can limit or thwart expansion plans.

Following is a description of the various buses available (Figure 5-1):

- **ISA:** The first Industry Standard Architecture (ISA) bus was introduced with the original 8088-based PC/XT in 1980. It can address 8- and 16-bit devices, and has DMA capability. When the 16-bit 80386 PC/AT was introduced, it kept the original 8-bit bus, but added a 16-bit connector for 16 data lines and 24 address lines. This did not increase bus speed, but it allowed the bus to address

more memory. Neither of the ISA buses can act as a bus master. Many plug-in boards list both PC/XT and PC/AT compatibility, and many modern computers still have one or more ISA expansion slots.

- **EISA (Extended ISA):** Another progression of ISA, this generation added support for intelligent bus-master expansion cards. This is important because if the data acquisition board

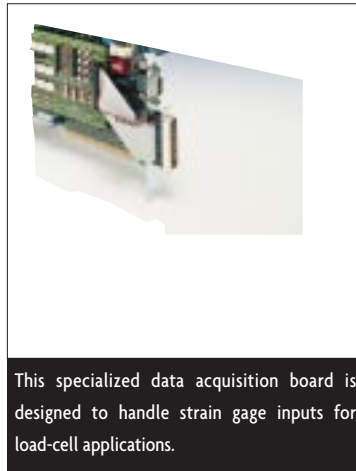

This specialized data acquisition board is designed to handle strain gage inputs for load-cell applications.

cannot take control as a bus master, it may not be able to transfer data any faster than an ordinary ISA board. With bus mastering, the data acquisition board makes the DMA transfer at the highest possible rate. EISA supports 8-, 16-, and 32-bit data transfers at speeds up to 33 Mbps.

- **MCA:** The ill-fated Micro Channel Architecture is a feature of IBM's PS/2 computer. Its proprietary architecture thwarted PC-compatible manufacturers, so it was never a success outside IBM. Few plug-in data acquisition boards are available for the MCA system.

- **VESA:** The Video Electronics Standards Association developed the VESA bus primarily to maximize throughput for video graphics in the 80386/486 environment. It adds a

local bus for faster access to the processor, and supports limited data bursts up to 132 Mbps. Like the MCA bus, it enjoys only limited success outside its industry, and few plug-in data acquisition boards are available for it. Those that are available typically are intended for use in the video industry.

- **PCMCIA:** The Personal Computer Memory Card International Association (PCMCIA) developed this interface for small computers, such as notebooks and laptops. Its popularity skyrocketed, and today virtually every portable PC has PCMCIA slots. It supports 8-, 16-, and 32-bit data transfers. Plug-in data acquisition boards are available that operate at speeds to 100 kHz.

- **PCI:** The Peripheral Component Interconnect (PCI) bus is a processor-independent bus that supports up to 64-bit addressing, bus mastering, and burst transfer rates up to 1,056 Mbps (132 Mbytes/second). The standard is still evolving, with developments such as the CompactPCI standard for industrial applications, and hybrid versions that work with VME, PMC, Multibus, and STD. Virtually every Pentium PC being shipped today has a combination of ISA/PCI or EISA/PCI buses.

- **PC/104:** Intended for embedded computer applications, PC/104 cards are very compact at 3.6 x 3.8 in. PC/104 also allows card modules to self-stack without backplanes or card cages, and has pin-and-socket bus connectors designed for high reliability in harsh environments. It is, essentially, a miniaturized version of the standard PC bus architecture. Also in continual development, the latest generation (PC/104-Plus) operates at the same speed as PCI.

- **USB:** The Universal Serial Bus (USB)

is around the corner. Currently being offered in most commercial PCs, it is essentially an upgrade of the venerable RS-232 port. It will allow up to 127 USB devices to connect to a PC. USB peripherals will be automatically detected and configured when connected and could include virtually every peripheral device now being used, including keyboards, monitors, touchscreens, modems, and data acquisition devices. It operates at 12 Mbps. Almost no industrial data acquisition boards are available today, but many companies have them in development.

Buses for Apple computers are not nearly as complicated and diverse as PC buses, but specs vary from model to model. Until recently, Apple buses were based on two basic architectures: NuBus and Processor Direct Slot (PDS). Both are 32 bits wide. The NuBus is found in almost every Macintosh computer, while PDS provides very high-

MHz system bus and a 133 MHz “back-side” bus for 64-bit data transfers.

The G3 also comes with three 12-in. PCI expansion slots that are compatible with PCI 2.1 cards, two high speed DMA serial ports, and a built-in 10BaseT Ethernet connector, presumably for Internet/intranet connections.

Anyone considering plug-in data acquisition boards for either PC or Mac systems can be confident that both the computer processing hardware and the data acquisition boards are capable of handling just about any data acquisition job imaginable.

Standalone Components

In the previous section, plug-in data acquisition boards for PCs and Macs were examined. In this section, we will look at communications-based, or front-end, data acquisition systems—standalone data acquisition systems that collect data and send it to a processor over a data communi-

standalone data acquisition hardware can transmit its data to a PC, programmable logic controller (PLC), RISC workstation, midrange or mainframe computer, or even the Internet. A standalone system can gather one data point—such as an infrared sensor—or thousands of analog and digital measurement points.

Unlike a plug-in data acquisition system based on a commercial PC, standalone systems often are designed to be located anywhere on the plant floor. Ruggedized I/O modules, racks, power supplies, and sealed NEMA enclosures are readily available to house a data acquisition system, often at a lower cost than a similarly ruggedized industrial computer.

A plug-in data acquisition system is limited by the number of cards that can fit into the available slots of a PC or Mac. Also, when a data acquisition system gets overly large on a PC, it begins to take more and more processor time for DMA access, slowing even the extremely powerful processors. A standalone data acquisition system, on the other hand, can more easily grow to be as large as necessary. You can even start small, building and expanding the system as requirements grow.

Finally, standalone systems are portable from system to system. They operate with industry standard communications, so the I/O can be easily transferred from a PC to a Mac to a PLC as needed.

A plug-in board works with one type of processor only. Even more difficult, all the field wiring terminates at the data acquisition board. To change computers, you may face a monumental rewiring task, even when moving to a bigger and faster computer of the same type.

While a plug-in data acquisition

Figure 5-1: Computer Bus Architectures

BUS ACRONYM	BUS DEFINITION	NUMBER OF BITS	MAXIMUM SPEED (millions of bits/second, Mbps)
ISA	Industry Standard Architecture	8, 16	1.6
EISA	Extended ISA	8, 16, 32	33
MCA	Micro Channel Architecture	16, 32	33
VESA	Video Electronics Standards Association	32	132
PCMCIA	Personal Computer Memory Card International Association	8, 16, 32	132
PCI	Peripheral Component Interconnect	32, 64	132, 1056
PC/104	(ISA in a smaller, more rugged form factor)	32	132
USB	Universal Serial Bus		12
NuBus	(Macintosh bus)	32	33
PDS	Processor Direct Slot (Macintosh bus)	32	132

speed communications.

It is more interesting to look at the latest Macintosh to see what direction Apple is going. Its latest computer, the Power Macintosh G3 has a 233 or 266 MHz PowerPC processor and two processor buses: a standard 66

MHz system bus and a 133 MHz “back-side” bus for 64-bit data transfers. Data communications involve everything from a simple RS-232 connection to a high-speed network (Chapter 4).

One major advantage of communications-based systems is that they are processor independent. A “box” of

board represents the most efficient and most economical solution to many data acquisition applications,

way to connect sensor field wiring to signal conditioners, converters, power supplies, terminal blocks,

ing and matching of I/O devices from several different systems.

Depending on the plant environment, the DIN rails can be mounted in cabinets, racks or NEMA enclosures. Field I/O wiring is brought to the enclosure, and typically connects to termination modules or directly to the signal conditioners.

In most cases, DIN rail devices do not perform any processing of field data other than signal conditioning and conversion. Instead, they serve primarily as a termination and distribution point for field I/O. For data acquisition purposes, DIN devices gather sensor data and distribute it to downstream equipment through RS-232/RS-485 links, various fieldbus or device networks, or other types of communications systems.

Rack-mounted data acquisition systems have been around since the beginning of the industrial control industry. This solution involves I/O modules, subsystems, and processors that are installed in a standard industrial 19-in. rack that's housed in a NEMA free-standing or wall-mounted enclosure. Subsystems and processors typically mount horizontally across the enclosure, while I/O boards and processor cards mount vertically in a card chassis.

The card chassis usually has a built-in power supply for all the I/O and processor cards that plug into it. It may also include a backplane, as in the case of VMEbus and VXIbus, to interconnect the cards and processors. In other systems, a large power supply mounted at the bottom of the enclosure provides conditioned, noise-free power to every module.

Rack-mount systems can accommodate PLC I/O, data-logging systems, remote I/O for a computer, field networks, and just about every



standalone systems have more capability and flexibility. Remember, plug-in boards for PCs and Macs are a relatively new product—they are not more than 15 years old. Standalone systems have been evolving for 35 years or more, since the first supervisory control and data acquisition (SCADA) systems of the 1960s. With hundreds of manufacturers worldwide, and tens of thousands of different devices and models, finding front-end data acquisition equipment to do the job is a much easier task.

• Connecting to Field I/O

When considering a standalone system, a major question that has to be answered is: How will the field I/O be connected? This involves a choice among several systems: DIN-rail systems, rack-mounted systems, and field-mounted devices.

A DIN-rail system is a convenient

relays, modems, power conditioners, surge suppressors and other devices in the field. The DIN rail is either 32- or 35-mm wide, and provides a sturdy platform on which dozens of devices can be mounted. A single power supply, surge suppressor, and communication module can serve a row of modules.

DIN modules are small, rugged, and designed for high-density installation. For example, high-density signal conditioners from one manufacturer can be packed so close together they can accommodate 52 analog signals in one foot of DIN rail, at a cost of about \$100 per point. DIN devices often are offered with universal foot mountings that accommodate 32- and 35-mm DIN rails and the Allen-Bradley rail. Adapters are available that allow any flat surface device to mount on a DIN rail. Both schemes allow mix-

type of front-end or I/O on the market today.

Historically, mV sensor signals have been wired to a transmitter or transducer that converts the signal into a higher voltage or a 4-20 mA current loop signal that is less susceptible to electrical interference (see Chapter 3). While this is still a perfectly acceptable technique, newer field-mounted devices are becoming available. One of the hottest topics in I/O today is the digital instrument network, which involves connecting sensors to data acquisition systems or host computers via a digital signal (see Chapter 4). Field-mounted transmitters of yesterday have become extremely powerful digital devices that do much more than convert data. “Smart” transmitters and I/O devices can now mount at or near the sensor location in junction boxes or sealed enclosures, and perform a wide variety of signal conditioning and processing functions locally.

- **Signal Conditioners**

Signal conditioners are available to handle virtually every sensor on the market today, including mV, V, mA, and resistance signals from RTD, thermocouple, potentiometer, strain gage, load cell, LVDTs, and frequency sensors, to name the most common.

In many cases, the signal conditioning consists of signal isolation, filtering, amplification, and linear conversion of signals ranging from ± 10 mV to ± 40 V to a more usable voltage.

For thermocouple inputs, signal conditioners linearize the incoming signal and perform cold junction compensation to increase accuracy. A thermocouple signal conditioner usually accepts inputs from types J, K, T, E, R, S, B, and N thermocouples.

RTDs may be 2- or 3-wire. For sensors that require an excitation voltage, such as a strain gage or load cell, the signal conditioner supplies it.

DIN-rail signal conditioners are narrow devices that often accommodate only one signal at a time and have a selectable output from 0-5 V or ± 10 V, 4-20 or 0-20 mA, and RS-232 or RS-485 communications. With RS-485, up to 32 modules can be connected to a single computer communications port.

Signal conditioners in rack systems are full-size I/O boards that plug into the chassis. Sensor signals terminate at the I/O board or onto terminal panels. A typical analog input board accepts 8, 16, or 32 channels. Unlike multifunction PC boards, rack systems tend to specialize. For example, all digital I/O goes to a digital I/O card, thermocouples go to a thermocouple input board, and so on.

Field-mounted signal conditioners have the same capabilities as DIN-rail and rack-mount devices, but are packaged in tougher enclosures. Some are in “hockey puck” packages, others in I/O “bricks.” Both can be mounted near the sensor in benign environments, or housed in junction boxes or small enclosures if the environment is more difficult.

- **Transmitters**

A traditional analog transmitter takes a sensor signal, amplifies and conditions it, and sends it on its way as a 4-20 mA signal that is relatively noise immune and intrinsically safe if necessary. In a two-wire system, power for the transmitter’s electronics is taken from the current loop. In a four-wire transmitter, power is provided from an external source on a second set of wires.

As you might expect, today’s tech-

nology has gone far beyond this point. Many of today’s transmitters are “smart” devices that communicate to a host PC or PLC via a digital signal superimposed on the 4-20 mA current, or by RS-232, RS-485, or other digital networks (Chapter 4). Embedded microprocessors perform diagnostics and self-calibration, and accept programming and setpoint information from a host processor. Smart transmitters also can be configured remotely for any number of tasks, thereby cutting down on the number of different transmitters needed for spares. Power for the transmitter is supplied by the 4-20 mA current loop, the phone line in a modem-equipped device, or by the RS-232 line.

Some smart transmitters accept two sensor inputs, using one as the primary and the other as a hot backup. If the primary sensor fails, the transmitter switches over instantly and notifies the host. More and more system responsibility is being off-loaded to smart transmitters. In one system, the transmitter does not send data at all, unless it has changed from the previous value. In another, outputs from three transmitters are evaluated by a two-out-of-three voting scheme to determine which one has seen a false input (for example, flame-out in a flare stack application).

- **Alarm Modules**

With computer processors available at all levels of a data acquisition system, the need for alarm modules has diminished. When independent local alarm indication is needed, however, alarm modules are an ideal solution.

DIN-rail mounted alarm modules typically accept an ac or dc voltage or current input signal, or a temperature reading from a thermocouple or RTD, and compare the input with high and

low setpoints. The limit alarm can be field configured for high or low, fail-safe or non-fail-safe operation.

Alarm modules have one or more relay outputs for sounding audible alarms or illuminating a panel annunciator. When the operator investigates, the alarm module has LED indicators that show input status.

• Remote I/O

Many PLCs and computer-based control systems use remote I/O to collect data in a far-off location, from a work cell where sensors are concentrated, or from various convenient locations in a plant. The remote I/O system serves as a data concentrator, minimizing the amount of physical cabling needed to directly connect each field I/O point.

In some cases, the I/O for a PLC is assembled into a cabinet by the vendor—complete with analog and digital I/O, termination cards, signal con-

ditioners, and other devices. The remote system communicates with its host over a communications network. Computer-based control systems can use remote I/O made up from digital and analog I/O boards from a wide variety of vendors, sent over any of several data communications schemes. In many cases, a large control system spread over a plant floor may be taking data from entirely different types of data acquisition equipment. Information coming from a testing lab might be originating in analyzers and instruments that use the IEEE-488 standard; real-time data from a batch reactor may consist of dozens of 4-20 mA flow, pressure, and temperature transmitter signals coming in over a fieldbus network; and information from the inventory control material-handling system could be motion control data from resolvers, encoders, and limit switches gathered by a PLC and made available on a PLC communications network.

• **Front end:** A front end is simply a dedicated I/O system that is set apart from the host computer or controller. The two systems are phys-

ically separated, with all or most of the I/O concentrated in the front end. A front end typically connects to the computer via one or more parallel cables that support a 32- or

Communications Devices

64-bit interface. The front end may connect to multiple remote I/O units, networks, serial I/O, or PLC data highways.

No-fuss data communications have contributed much to the world of data acquisition. From telephone modems to wireless networks, a broad variety of specialized data communication devices are available to suit every communication need.

• Modems

Using telephone wires, twisted pairs, or fiber optic cable, modems transmit and receive serial, digital data. You may be familiar with the current 56 kbps (actually, it's 57,600 baud) controversy on the Internet, with two competing, incompatible suppliers claiming that they can achieve such data rates over commercial phone lines. Such a modem has been available for years in the industrial world, but it requires special isolated circuitry. Achieving higher data rates for serial data often requires fiber optics. Examples of modems available for data acquisition include:

• **Limited distance modem:** Low-cost (\$86) general purpose modems can be used to transmit non-critical data up to 12 miles. As distance increases, transmission speed decreases. At 12 miles, speed is 1.2 kbps. At one mile, speed is 19.2 kbps, and at one half mile, 57.6 kbps. It requires four wires (two twisted pairs) for full duplex operation. To achieve the highest speed of 57.6 kbps, special high-speed, optically coupled circuits are required.

• **Fully isolated modem:** When data is important, it must be protected against noise, common mode voltage problems, and electrical transients.



General purpose modems are a low cost option for sending digital information at rates up to 57.6 kbps.

ditioners, and other devices. The remote system communicates with its host over a communications network.

Computer-based control systems can use remote I/O made up from

ically separated, with all or most of the I/O concentrated in the front end. A front end typically connects to the computer via one or more parallel cables that support a 32- or

Optical isolation and dc-to-dc transformer coupling create an isolation barrier of 1000 V rms (root mean squared). An isolated modem has the same transmission speed as a limited distance modem.

- **Signal-powered fiber optic modem:** In particularly nasty environments with much electrical noise, a fiber optic modem can be used. Signals on fiber optic cable are immune to EMI and RFI. Simple, low cost (\$127) fiber optic transmitter/receivers can be plugged into the RS-232 ports at both ends of the link. The transmitters take their power from the RS-232 port, and transmit data at 19.2 kbps for up to 2.2 miles.

- **High-speed fiber optic modem:** This device transmits RS-232, RS-422, or RS-485 data at speeds up to 5 Mbps 1.2 miles over a fiber optic link. As above, the transmitter/receiver plugs into the data port at both ends. For more distance, a repeater can be installed.

• **Wireless Systems**

Before the advent of reliable radio data transmission for reaching remote locations, communications required hard wiring. Wires had to be strung on utility poles or underground. This is neither cheap nor convenient. Today, transmitting data by radio-frequency (RF) links is becoming widely acceptable. RF links are available in several varieties:

- **Microwave:** Requiring line-of-sight between antennas, microwave systems can transmit data up to 32 miles. Such a system consists of an operator base station that can communicate with one or more remote terminal units (RTUs). Each RTU has a microwave two-way radio and an antenna. Data acquisition equipment at the remote site connects to the

RTU via RS-232 or RS-485 ports. Typical cost of an RTU or base station is \$3,000 to \$5,000.

- **Unlicensed link:** These narrow-band units operate in the 900-MHz band, and work at distances to 1 mile. With antennas or repeaters, distance can reach 90 miles at speeds to 115 kbps with a response time of 5-15 milliseconds between units.

- **Spread spectrum:** When interference is present in the 900 MHz band from telephones or other 900-MHz devices, spread spectrum radios “frequency hop” from 902 to 928 MHz to get away from the offending interference. At distances under one mile, line

these systems out of metro areas. Utilities in outlying areas are big users of licensed systems.

- **Trunked or cellular:** For hilly, mountainous, or city settings where line-of-sight systems are impractical, trunked radio is a solution. The radio signal is transmitted through repeaters by the same service providers used by taxicabs. Cellular telephones also can be used to transmit data in such situations.

• **Protocol Converters**

As noted above, any data acquisition system might mix and match components and transmit data over multiple



Automatic dialing systems are designed to alert people—or supervisory systems—about remote alarm conditions via standard phone lines.

of sight is not always necessary for communications. Spread-spectrum radios can achieve full duplex uncompressed data rates of 115.2 kbps.

- **Licensed RF:** If data acquisition needs cannot be met by 900-MHz devices, devices that operate on licensed frequencies can connect up to 10,000 remote units. The limited availability of frequencies keeps

interfaces. Protocol converters help a great deal in the interfacing of various hardware. Some of the wide variety of converters available include:

- **IEEE-488 to RS-232/422:** Provides a transparent interface between two dissimilar devices. For example, it allows an IEEE 488 instrument to communicate with an RS-232 printer or plotter. Conversely, a PC with an

RS-232 port could communicate with an IEEE-488 device. Such converters are available with one port for device-to-device communications, or with multiple ports.

- **IEEE-488 to Mac:** Connects to SCSI port on Macintosh computers, allowing the computer to control up to 14 IEEE-488 devices.
- **RS-232 to RS-422:** Converts an RS-232 signal to RS-422, with complete signal isolation. It allows an RS-232 device to get onto an RS-422 multi-drop system. RS-422 supports up to 32 devices.
- **RS-232 to RS-485:** Similar to above, this converter lets an RS-232 device get onto an RS-485 multi-drop system. RS-485 supports up to 64 devices.

• Auto Dialers

An auto-dialer monitors conditions at a remote site and, if an alarm condition develops, alerts people or other equipment. It is a small, self-contained data acquisition system that monitors one or more key digital or analog sensors. In almost all cases, it has automatic dial-out capability that will continue to call a series of phone numbers until someone answers. It then delivers a preprogrammed voice alarm message.

At the low end, systems with voice-only outputs start at about \$395. One such a system monitors one temperature and three contact closure inputs. When an alarm condition develops, it dials multiple phone numbers and delivers a prerecorded voice message. It continues to call until someone properly acknowledges the message.

As features are added, costs and capabilities increase:

- Additional analog and contact closure inputs allow more systems to be monitored.
- Digital speech recording allows multiple messages to be recorded and assigned to various alarms.
- An RS-232/485 interface allows the

system to call up a computer or controller to deliver an alarm message and transmit data.

- A built-in data-logger function stores data about the event for later analysis.
- Local digital and analog outputs allow alarm and control functions to be programmed. 

References & Further Reading

- *The Data Acquisition Systems Handbook*, Omega Press LLC, 1997.
- *New Horizons in Data Acquisition and Computer Interfaces*, Omega Press LLC, 1997.
- *Omega® Universal Guide to Data Acquisition and Computer Interfaces*, Omega Press LLC, 1997.
- *Data Acquisition and Control, Microcomputer Applications for Scientists and Engineers*, Joseph J. Carr, Tab Books Inc., 1988.
- *Data Communications, A Beginner's Guide to Concepts and Technology*, Scott A. Helmers, Prentice-Hall, Inc., 1989.
- "Flying Your Plant by Radio Control," Dan Herbert, *Control*, August, 1996.
- "How to Improve Industrial Data Communication," Michel E. Maes and James R. Steffey, *Control Engineering*, March 1996.
- *Instrument Engineers' Handbook, Third Edition*, Bela Liptak, Chilton Book Co., 1995.
- "Microcontrollers and the Design Engineer," Julie Anne Schofield, *Design News*, June, 1997.
- *Modern Digital and Analog Communication Systems*, B.P. Lathi, Holt, Rinehart, & Winston, 1983.
- *PC Bus Performance Brief: PC Bus Overview*, Intel Corporation, 1997.
- "PC-Based Equipment Can Offer High-Speed Data Acquisition," Jeffrey R. Payne and Bradford A. Menz, *Plant Engineering*, November, 1996.
- *PDS Expansion Interface Q&A*, Developer Support Center, Apple Corp.
- *Process/Industrial Instruments & Controls Handbook, Fourth Edition*, Douglas M. Considine, McGraw-Hill Inc., 1993.
- "Radio Days," Paul Studebaker, *Control*, April, 1997.
- "A Road Map to Successful Data Acquisition Board Selection," Chad Chesney, *I&CS*, October, 1997.
- "Temperature Transmitters Go Upscale," Dan Herbert, *Control*, March, 1997.
- *What is PC/104?*, PC/104 Consortium, 1994.
- "Wireless Modem Offers Fast, Accurate Data Transmission," Peggy Piper, *Control*, May, 1997.

- Development Considerations
- Component Architectures
- Off-the-Shelf Offerings

Prior chapters have covered the mechanics of acquiring data from various sources and translating this data into bits and bytes. This chapter will focus on tools available to translate data into worthwhile information. These tools are primarily programming languages and off-the-shelf software packages running under Microsoft Windows and Macintosh operating systems on personal computers.

The steps required to select a data acquisition software program are:

- 1) determine the features and performance necessary to accomplish the task at hand;
- 2) determine the available resources of time, money and expertise; and
- 3) select the tools to perform the task.

Selection of tools requires investigation of available software programs and languages, and of operating systems under which these programs and languages will run.

Various versions of Microsoft Windows have come to dominate the operating system market for PC-based data acquisition systems. Many data acquisition software packages are designed to run on more than one operating system, but the Windows operating system is almost always one of the available choices.

At one time the technical performance of Windows was significantly inferior to other more "real-time" systems. More recent versions of Windows, however, have largely ameliorated the real-time problem, either through the operating system itself or through the use of various operating system extensions. These

extensions improve the real-time performance of Windows and allow for deterministic scan times.

As in the office, the OS/2 and Macintosh platforms seem destined to recede in market share, investment, and new software applications. The relative technical merits of PC operating systems were an interesting area for discussion several years ago, but these considerations have receded into the background as much of industry has standardized on the Windows platform.

One big difference remains between office and industrial operating systems. There remains a strong market for low-end, embedded applications in the industrial arena. There is no analogy for this in office computer systems. Original

thousands need a low cost solution that addresses the task at hand with no wasted overhead. This market continues to be addressed by DOS/386 machines, often in compact form factors such as PC-104 or STD. OEMs with embedded hardware/software solutions often continue to use just enough horsepower to solve the task at hand.

Development Considerations

Once the operating system is selected, the next decision to be made is whether to write custom software or to buy an off-the-shelf package. Writing software is much like cooking dinner, and buying an off-the-shelf package is like eating at a restaurant. If you are good in the kitchen, it may be better to

Presentation & Analysis

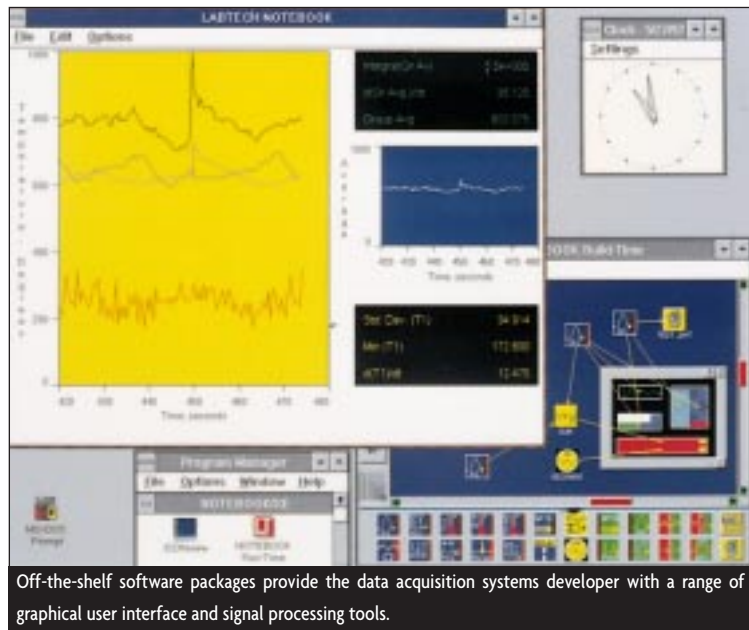

Off-the-shelf software packages provide the data acquisition systems developer with a range of graphical user interface and signal processing tools.

equipment manufacturers (OEMs) with product runs in the tens of

cook. The dinner may be less expensive—although a bit more work—

and customization will be easier.

The risks of cooking dinner (writing software) are the very real possibilities of a bad cook (programmer), or bad ingredients (wrong programming platform), or both. Furthermore, it is very difficult to determine if the dinner is bad until the cooking is finished. Only the most experienced master chefs (programmers) can determine the probability of a bad meal (program) early on in the task. After the cooking (programming) is done, it is too late and too expensive to start over. Even the best chef may not be able to rescue a poorly prepared dinner.

The restaurant (off-the-shelf) is a more dependable and initially more expensive approach. Much depends on the reputation and reliability of the restaurant (software vendor). The best restaurants consistently deliver high quality meals, and stand behind their offerings if things go wrong.

Custom software requires the involvement of at least two people at all stages of software development. The application expert must understand the problem and transfer that knowledge to the programmer. The programmer must then write the software and review the completed program with the application expert to close the loop. Training an application expert to be a programmer is rarely feasible because the learning curve is steep and is measured in months or even years.

Off-the-shelf software usually can be configured by an application expert. Training is required, but typically is measured in weeks. This greatly reduces development time because communication problems and delays between the experts and the programmers are eliminated. Expenses also are lower because fewer people are required to complete the project.

Figure 6-1 shows some of the relative merits of writing code versus the off-the-shelf approach.

The majority of applications are well suited to off-the-shelf programs. The chief drawback to these programs has been the high cost of software licenses. A full-featured data acquisition program used to cost in the neighborhood of \$2,000, but prices today are closer to \$1,000 and continue to fall. These low prices mean that custom software's price advantage is only apparent in rare situations where the software cost is high relative to the total system cost and where product runs are in the thousands.

costs prohibitively high, especially if market share is split among many software vendors.

Off-the-shelf programs are at their best in the related areas of support cost, modification cost, and risk of obsolescence. Assuming the right software vendor is chosen, a user can expect regular upgrades. These upgrades should accomplish the following while protecting the investments made in existing application software:

- **Fix bugs:** All software has bugs. Good vendors listen to their clients to find these problems and promptly issue bug fixes, or at least workarounds.

Figure 6-1: Cost of Writing vs. Buying Software

ATTRIBUTE	WRITE IT	BUY IT
Initial cost	Low	High
Cost of subsequent copies	None	Relatively high (but falling)
Customization	Infinite	Restricted (but improving)
Cost to modify	High	Low if desired changes are part of upgrades, very high or impossible otherwise
Cost to support	High	Low if upgrades address bugs in a timely manner
Customer acceptance	Low	High
Risk of unusable program	High	Low if right vendor is selected
Risk of obsolescence	High	Low if right vendor is selected
Speed	High	Low
Use of system resources	Low	High

Off-the-shelf programs score high in customer acceptance. Clients are much more apt to purchase a data acquisition system with name-brand software. In fact, to most clients the software is the system because software is the front end seen day in and day out.

The drawback (from a systems integrator's point of view) to customer acceptance of off-the-shelf software is the necessity of complying with client demands for their specific brands of software. This can make development and support

- **Incorporate new features:** Each new revision should add important product features.

- **Provide customer support:** Upgrades for most data acquisition software can now be purchased as part of an annual support agreement. These agreements generally require an annual investment of 10-20% of the initial cost of the software. This investment yields regular upgrades and comprehensive customer support including phone hotlines, Internet, e-mail, and newsletters.

- **Maintain backward compatibility.**

One area where off-the-shelf software has traditionally been weak is flexibility for customization. This is changing rapidly as most packages now offer developer toolkits for creation of custom features. These toolkits allow a user to program special functions in a popular programming language such as C++. These functions can then be seamlessly integrated into the application program. Special software functions must be developed to comply with toolkit specifications. This reduces the cost of support because the toolkit specifications standardize software customization.

When is the write-your-own approach effective? An OEM with a planned product run of thousands of units would probably choose to write a data acquisition program, especially if the cost of software made up a large percentage of total product cost. The high cost of subsequent copies of off-the-shelf software would tend to outweigh all other factors. Another situation necessitating home-grown software would be an unusual application not addressed by commercially available programs.

Many of these types of applications involve high-speed data acquisition. In these applications, system resources must be concentrated on speed and not on the overhead required to support off-the-shelf programs. Another compelling reason to write your own software is to minimize the use of system resources such as processing power and memory. Many OEMs find that custom-written programs can perform quite adequately on DOS/386 machines with minimal memory. This can significantly reduce the total cost of the data acquisition system.

On the negative side, obsolescence is a major problem. This is because home-grown software must incorporate the latest advances in the field in order to remain competitive. Large software firms with thousands of customers can afford to write such features into the next release of their programs, but firms

component software, tends to be self-documenting and lends itself to standardization. Component software uses programming languages such as Visual Basic, C++, or Java to create blocks of software. Each block of software performs a specific function. These function blocks can be encapsulated together to

Figure 6-2: Advantages of Component Software

DRAWBACKS OF CUSTOM SOFTWARE	COMPONENT SOFTWARE SOLUTION
High initial cost	Software blocks written by others for similar applications can be reused; much of the initial programming effort is eliminated
High cost to modify	New component software blocks can easily be added to existing programs
High cost to support	Can be controlled if original program blocks are tested properly
Low customer acceptance	"Brand name" development environments such as Visual Basic increase customer acceptance
High risk of obsolescence	Risk is lessened because new features can be added by adding new blocks of software (assuming the original platform is still viable)

not in the software business tend to put their development dollars into their primary products instead of ancillary software programs.

Another problem with custom software is high cost for modification and customer support. Custom programs usually are authored by a small group of programmers, or even by just one person. A firm can become highly dependent on a very small group of employees, and if these employees are no longer available, support can be extremely expensive and difficult. Even when the original author or development team is available, prices may rise dramatically as they grasp their negotiating leverage.

Component software claims to address many of the problems associated with support and modification of custom programs. The next section will address the problems and promise of this new methodology.

Component Architectures

Software written with object-oriented languages, also referred to as

create procedure blocks. Function blocks are then linked to each other or to procedure blocks to create a software program.

Blocks of software usually can be tested independent of one another. Once a block is written and tested, it can be put into a library for later use. Blocks written by one programmer can be used by another programmer to create a complete software program. Software blocks can also be downloaded from various Internet addresses.

A data acquisition software program written with component software thus becomes a collection of linked blocks of software. Because the operation of each block of code has been tested and verified, programming only requires the correct linking of these blocks.

As Figure 6-2 illustrates, component software can overcome many of the problems associated with custom software. This figure would seem to indicate that component software is the ideal solution, combining the flexibility of custom soft-

ware with the customer acceptance of off-the-shelf programs. This is true to some extent but only if the development platform remains viable and discipline is followed when the software is written and modified.

Long-term viability of the software development platform is critical. It is more important to pick a strong brand name with staying power than to strive for the latest features. If the selected platform vendor goes out of business, the software developer is in trouble. All programs developed with the discontinued software platform immediately become obsolete. Bugs are not fixed, industry advances are not implemented, and most importantly, programmers begin to discontinue development of new software blocks.

The remaining problem with component software is the necessity of maintaining a disciplined approach to software development and support. Relatively small blocks of software code are inherently easier to support than one large monolithic program, but these small blocks of code must still be written in a manner to allow subsequent modification and support. Software blocks must be large enough to perform important functions but not so large as to become unwieldy. The blocks must be developed in a prescribed manner so as to allow communications with other blocks. Judgment and discipline still are required to develop maintainable software.

• Objects & Containers

The latest advances in object-oriented development for the Microsoft environment include objects based on Microsoft's Component Object Model (COM), and its distributed extension, DCOM. Formerly known as ActiveX "controls," these objects are created

with development systems such as Visual Basic, Visual C++, Borland Delphi, and Microsoft Internet Explorer. Once an object is created it is compiled and tested within the development system. Each ActiveX object follows a prescribed specification, namely 32-bit Object Linking and Embedding (OLE). This allows ActiveX objects to run within OLE control "containers," and to communicate with each other and with other OLE-compliant software.

OLE control containers act as platforms for COM/DCOM-based objects. These objects run inside these containers, communicating with each other and with other objects within the container. Any COM/DCOM development system can act as a container. Other containers of interest to users of data acquisition systems include many of the leading data acquisition software packages,

constitutes a working program, albeit not a very effective one. It is only when these objects are combined that useful applications are created to solve real-world problems. The standalone characteristic of an object is nonetheless important because it allows each object to be fully tested in isolation. This greatly simplifies software debugging.

Each object is a block of code, much of which is invisible to the user. Users typically work with only the compiled code and are not allowed access to the source code. Users access the object through its Properties, Events, and Methods. Methods are the least accessed of these parameters. Most object developers intend for users to interact with the object through its Properties and Events. An object can appear as a push-button, an analog or digital display, or as a much more

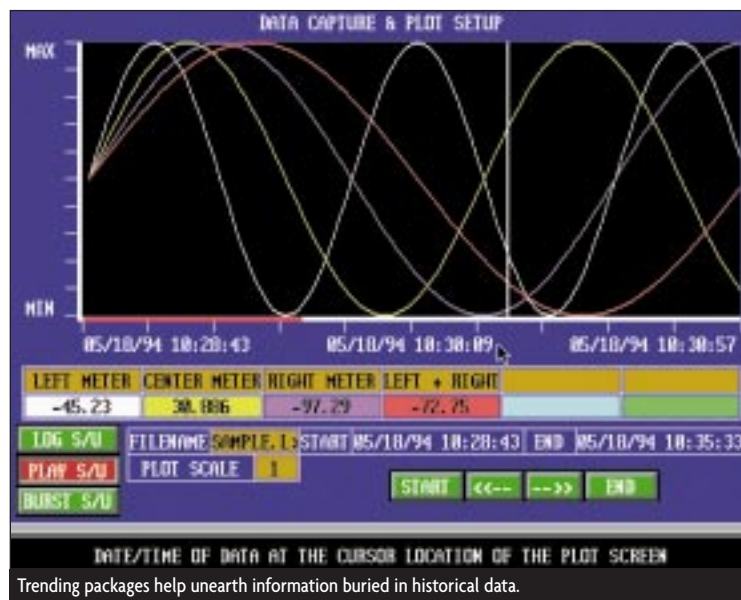

especially on the high end, as well as commercially available word processor and spreadsheet programs.

One object within a container

constitutes a working program.

Properties are used to define the visible attributes of the object. For example, a gauge might have the

Property of color. This would allow a user to change the color of the gauge. The power of the user to customize the object is determined by the number of Properties. Users want a large number of Properties to increase their ability to customize the object.

On the other hand, the developer wants to minimize the number of Properties. The object grows in complexity and size as more Properties are created. The developer can also lose money by creating too many Properties. If the Property of color is not available to the user and if the user cannot use the standard color, the user must purchase another object from the developer.

Events are the user-accessible items in the object that allow interaction between the object and the outside

Many of these vendors will sell these blocks over the Internet.

In theory, a user will soon be able to purchase a low-cost container and fill it with the needed objects. These objects can then be interconnected to create the program. The user could then apply this software program to an application, or become a developer by selling this application to others.

• **Semi-Custom Software**

A compromise approach to custom software development and often inflexible off-the-shelf packages are commercially available, graphically oriented programming environments. These programming environments typically consist of a group of function blocks, each dedicated to a data

comparison, data conversion, digital signal processing, data I/O, logic, math, string manipulations, waveform generation and statistical calculations. Free-form blocks also are included. The power of this type of program is evident. Virtually any application can be addressed if enough system resources are available and if high-speed data acquisition is not a requirement.

The line between these types of programs and non-custom, off-the-shelf programs is sometimes murky. Costs tend to be similar, although semi-custom software yields a wider range of functions for the money. Figure 6-3 illustrates some of the main differences.

Semi-custom development environments are a middle-of-the-road approach between writing your own software and buying an off-the-shelf package dedicated to a specific task. One of the most important differences is in the use of hardware resources. Many limited function, off-the-shelf programs can run in a DOS environment on a bare-bones 386 machine. This can be very attractive to an OEM needing an embedded, low-cost solution.

Semi-custom programs by necessity operate only in graphical environments. These types of environments demand the use of a high-powered PC. Throw in a 17-in., high-resolution color monitor, and you have a high-end solution to what may be a low-end problem.

The chief advantage of the semi-custom approach is high flexibility compared to off-the-shelf programs, coupled with relative ease of use compared with writing code. If a user has many different types of data acquisition applications, or if the data acquisition task cannot be clearly

world. For example, an Event for the gauge might be a change in the input value. This would move the needle on the gauge. Another Event would allow a user to set high and low alarm set-points for the gauge. Like Properties, Events create usefulness for the object but also add complexity and cost.

Leading vendors of data acquisition software now are selling ActiveX objects. These objects are sold in sets and are meant to address particular classes of applications. They are developed either internally by the vendor, or developed by third parties and private-labeled by the vendor.

acquisition or a data manipulation task. Drawing tools and libraries of standard symbols are also provided to create presentation screens.

Users connect the function blocks to each other to create applications, and also fill-in-the-blanks within each block to configure the software for their specific application. Screens are then drawn using the provided drawing tools and library symbols. Finally, screens are linked to function block fields to create animation and live data displays.

One popular program offers function blocks for communications,

Figure 6-3: Semi-Custom Development vs. Off-the-Shelf Packages

ATTRIBUTE	SEMI-CUSTOM	OFF-THE-SHELF
Cost per range of functions	Low	High
Cost of customizing for application	Moderate	Low
Ease of use	Moderate	Very easy
Customer acceptance	Moderate	High
Risk of obsolescence	Moderate	Low
Speed	Slow	Moderate
Use of hardware resources	High	Moderate

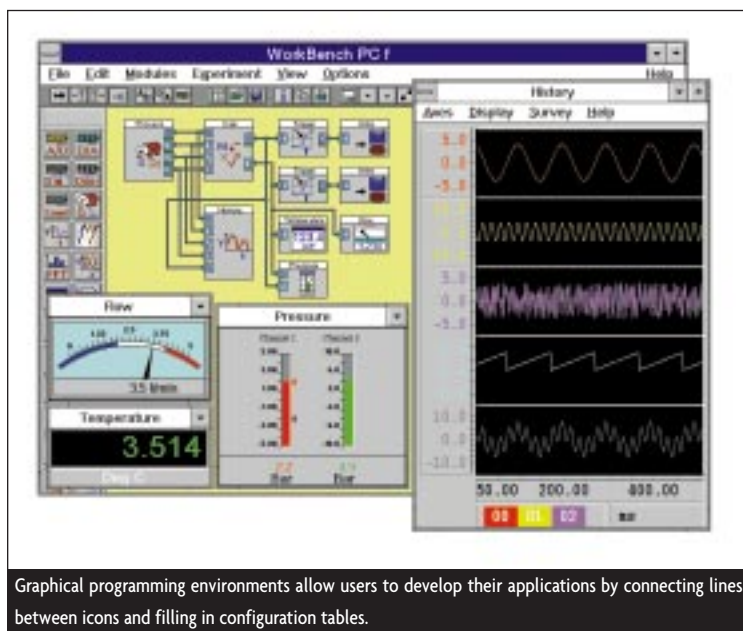

Graphical programming environments allow users to develop their applications by connecting lines between icons and filling in configuration tables.

defined, semi-custom software may offer the optimal solution.

Off-the-Shelf Offerings

If the decision has been made to go with off-the-shelf software functionality, it is important to remember that many data analysis programs do not offer data acquisition. This necessitates the purchase of a separate data acquisition program, and the integration of this program with the data analysis and presentation program.

Another scenario dictating the separation of data acquisition and data analysis is when budget constraints do not allow for the purchase of an integrated data acquisition and analysis program. The low cost option in this case is to procure a data acquisition software program only capable of acquiring data, storing data, and exchanging this data with an application software program. These data are then made available for access by any program through standard data exchange for-

mat such as DDE. These data-acquisition-only programs have limited functionality and correspondingly low costs. They are often supplied with data acquisition hardware and bundled into the hardware price.

A data-acquisition-only program can interface to a spreadsheet program via DDE or OLE. The spreadsheet program then can display these data in either a tabular or graphical format. Data also can be analyzed using the standard functions available with the spreadsheet program. This approach can be used for any type of data analysis and presentation program.

Drawbacks to this approach include slow rates of data exchange, and a lack of tight integration between the programs. Upgrades to one of the programs may cause difficulties with the other despite the presence of industry standard data exchange formats. Finally, vendors of data-acquisition-only software tend to be small in size compared with

vendors of data acquisition/analysis/display software—this heightens the risk of obsolescence.

If these drawbacks are not critical, then it is possible to select the best data analysis and presentation program without regard to data acquisition functionality. If a user must have an integrated data acquisition/analysis/presentation solution, then selection of the best available software must be made from a more limited range of offerings.

The task of acquiring data acquisition software consists of five primary steps, ideally followed in the order given below:

- 1) Define the required data acquisition, analysis, and presentation features.
- 2) Determine if custom, semi-custom, or non-custom software contains the required features.
- 3) Select the custom, semi-custom or off-the-shelf software option based on the application and the available expertise.
- 4) If the custom option is selected, purchase the required tools and locate the right programmer(s) and the right application expert.
- 5) If the semi-custom option is selected, purchase the development environment and locate the right configuration expert and the right application expert. This would ideally be an application expert with configuration training and/or experience.

If the non-custom option is selected, purchase the off-the-shelf program and locate the right application expert. Have this application expert learn how to use the program.

If the custom option is selected, features are only limited by the ability of the programmer and the resources available. If the off-the-shelf, non-cus-

tom option is selected, a careful study must be made of available products to determine the software program best suited for the application.

The first step is to determine what data needs to be collected, and what type of analysis and presentation is required for the data. Options range from simple plotting of an analog variable versus time to extremely sophisticated mathematical analysis of multiple analog and discrete values. Data analysis techniques can be divided into three main areas as shown in Figure 6-4. Each of these types of data analysis software will

- Plotting one analog variable versus a second analog variable;
- Alarming variables when alarm points are reached, or when a variable exhibits certain behaviors such as a rapid change in value;
- Filtering variables to eliminate noise problems;
- Plotting historical data, including overlaying current data on historical data for analysis; and,
- Comparing sets of measured variables to desired results (whether manually entered or automatically generated).

display of analog data is an emulation of a digital panel meter. Bar-graph meters become bar-graph displays. A chart recorder is depicted as a graph with different colored trend lines replacing multi-colored inks. If correctly implemented, these techniques allow an operator only familiar with panel instruments to become instantly familiar with data displayed on a CRT.

Panel instrument replacement is a basic function of virtually all process monitoring software. The software also adds many other capabilities that build on these basic functions. Displayed data can be stored for later analysis or record-keeping purposes. New methods of data visualization can be implemented to create physical representations of plant processes.

For example, the liquid in a vessel can be shown to rise and fall based on the value of the corresponding analog variable. Liquids and gases can be shown to fill not only vessels, but also transfer lines. The status of various on/off devices can be shown by changing the color of the item, or by animating the display. A pump rotor can be shown to rotate if the pump is on. The range of display options is limited only by the imagination. The main drawback of this flexibility is the possible incoherence of the data display. Good screen design is required to ensure clear understanding by plant operating personnel.

Another powerful technique available with process monitoring software is the emulation of specialized laboratory instruments such as oscilloscopes. The software can be used along with the PC and the display to create a virtual instrument capable of equaling or outperforming its real world counterpart. In addition, the virtual instrument can

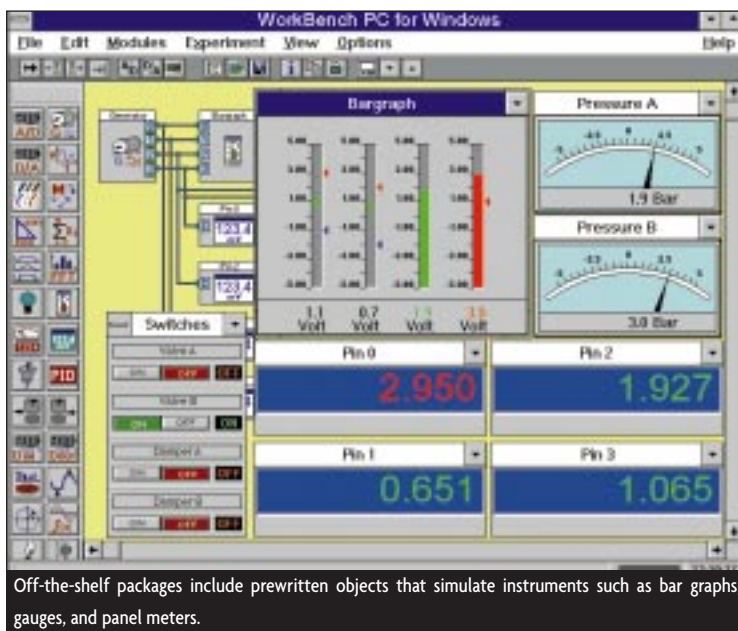

be examined in detail in sections to follow, starting with the most widely used application: process monitoring.

• Process Monitoring

Process monitoring is the simplest and most widely used of the data analysis techniques. Typical application examples include:

- Monitoring the setpoint, the output, and the process variable ver-

As its name implies, process monitoring is typically used in process industries to analyze the batch and continuous production of various products. At the most basic level, software-based systems replace functions previously performed by panel instruments. This is done by creating a numerical and/or a graphical representation of the panel instrument. For example, a

simultaneously emulate many different types or instruments, resulting in substantial cost savings.

The process monitoring features described above emulate the functions of panel and laboratory instruments. Sophisticated mathematical data manipulation software opens up an entirely new realm of data analysis and presentation.

• Mathematical Manipulation

In-depth analysis of data often requires the derivation of mathematical relationships, either among data or between data and other parameters. Many software programs are available to perform these types of functions. Most of these programs are not capable of data acquisition and only perform data analysis and presentation. These data analysis and presentation programs are designed to work in conjunction with data acquisition programs. The cost of these programs is usually less than for programs combining data acquisition with data analysis and presentation. They tend to be widely used not only for the analysis of collected data, but also for off-line analysis of entered or stored data.

This class of software programs can perform calculations on either real-time data (concurrent processing) or stored data (post processing). Multiple channels of data can be plotted against time, frequency, or other data. Zooming is supported along multiple axes. Plotted waveforms can be analyzed to yield minimum, maximum, and average values. Successive waveforms can be averaged to reduce the effects of noise. Data can be stored to disk or other storage medium, either as raw data or in a processed format using data compression. For example, an analog

variable might be sampled once a second and analyzed for variability. Only variations greater than one percent would trigger data storage.

and point-to-point. User-defined expressions can be compared to curves to determine the degree of fit. Curve-fitting equations, both

Figure 6-4: Primary Data Analysis Techniques

FEATURE	DESCRIPTION
Process monitoring	Analog and discrete data are collected and displayed in a graphical format. Data is usually displayed on a graph versus time, or another variable
Mathematical manipulation	Data is analyzed using various high-level mathematical techniques such as fast Fourier transform (FFT), curve fitting, filtering, etc.
Statistical analysis	Data is analyzed using various statistical techniques including X-bar and R-bar charts, frequency histograms, Chi-square analysis, etc.

Most of these programs support standard mathematical calculations of arithmetic, trigonometric, calculus, logic, correlation, and basic statistical functions. These functions can be performed on single data points or a group of data points (waveforms).

One of the most popular mathematical data manipulation techniques is fast Fourier transform (FFT). FFT is used to convert time-domain data to the frequency domain. This allows frequency spectrum analysis of data. One leading program calculates the amplitude and phase for multiple channels of data. The difference in phase angle is calculated to provide the transfer function, impedance, and frequency response. The power spectral density is specified along with the relative power for specified frequency bands. These calculated data can then be displayed on graphs in either linear or log format.

Another popular mathematical data manipulation technique is curve fitting. Software programs are available to plot data on two (curves) or three axes (shapes), and to analyze these curves and shapes to derive mathematical expressions. Typical curve-fitting mathematical functions are linear, polynomial least squares up to the tenth order, cubic spine,

derived and user-defined, can be ranked in terms of best fit.

For each set of data points the standard deviation and the correlation coefficient can be calculated in addition to the curve-fitted equation. Equations can be stored, and the recalled equations can be plotted against real-time or other stored data. Most curve-fitting software programs can also generate curves and shapes from tabular data.

Some common applications for curve-fitting software include the generation of calibration curves for flowmeters, optimization of process control parameters, and the generation of logistic dose response curves (concentration versus time and dose) for pharmacological research. Built-in kinetic equation functions can be used to study reactions and to describe biochemical responses. Kinetic functions also can be used to study the disappearance of a reactant (decay) and the appearance of a product (formation) over time. These kinetic models can determine the actual order of the formation or the decay.

Another related type of mathematical data manipulation is peak fitting. Peak-fitting software provides nonlinear peak separation and analysis, primarily for spectroscopy, chromatography, and electrophore-

sis applications. Overlapping peaks can be located and separated to aid in analysis. Noisy data can be processed using advanced data smoothing and manipulation techniques. Deconvolution techniques can be used to remove the data smearing often induced by data acquisition instruments.

base and half maximum, and asymmetry at base and 10% of maximum. Electrophoresis applications can be analyzed by separation of up to 100 peaks, even if they overlap.

New software programs are constantly being released to address specific types of mathematical analysis applications. Another area

functions include Chi-square analysis, Pareto analysis, distribution analysis, non-parametric analysis, correlation, single variable regression, multiple linear regression, and random number generation.

Many different types of control charts can be generated including X-bar, R-bar, histograms, and probability plots. These functions and charts are used in a wide variety of industrial applications.

A typical SPC application would be to measure the weight of a box of cereal. The actual weight would be compared to the desired weight and also to the boundary limit high and low weights on an X-bar chart. The software program would produce alarms to show a single unacceptably low or high weight; unacceptable weights could also be anticipated by alarming certain conditions such as successive weights trending towards a boundary limit, successive erratic weights alternating between high and low limits, or a number of sequential measurements close to a high or a low limit. Anticipation of an alarm condition could allow plant operations personnel to correct a problem before it occurs, thus avoiding unacceptable product.

Many of these software programs were originally written for applications not involving data acquisition. Data was expected to be entered manually or imported from other software programs. Support of data interfaces is often minimal. Fortunately, there are hardware and software methods available to address this issue.

• **Data Interface**

Once a decision has been made as to what type of data analysis and

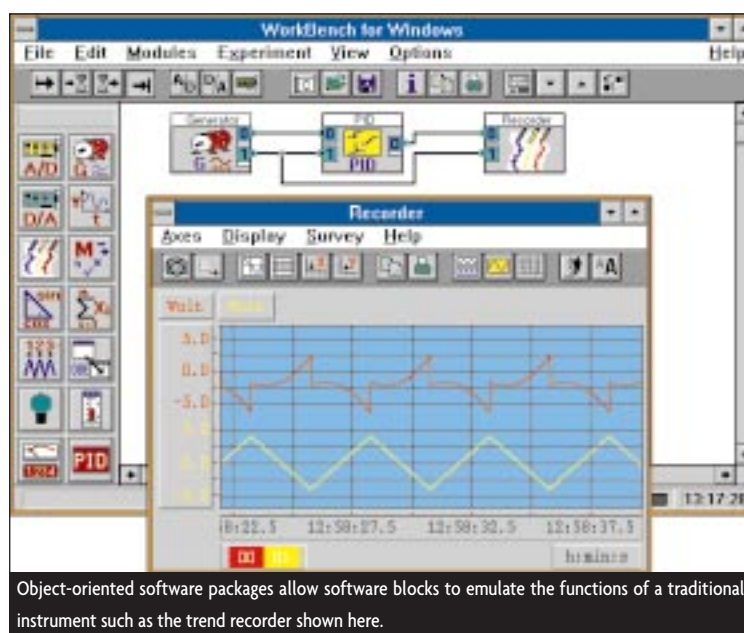

Object-oriented software packages allow software blocks to emulate the functions of a traditional instrument such as the trend recorder shown here.

Functions specific to spectroscopy applications include the identification of different nonlinear spectral application line shapes including the Gaussian, the Lorentzian, and the Voigt. Information reported for each peak includes amplitude, area, center, and width data. Overall area is determined by integrating the peak equations.

Chromatography applications are supported by equations such as the Exponentially-Modified Gaussian, the Haarhoff-Van der Linde, the NLC, and the Giddings. Data reported include column efficiency, resolution, first moment, second moment, and center as well as peak width at

where data acquisition software is widely used is for statistical analysis.

• **Statistical Analysis**

Statistical analysis software is widely used in industrial applications for quality acceptance, quality control, and statistical process control (SPC). These types of software programs analyze data to derive information with respect to the statistical relationships between or among data points. The most common supported functions include the calculation of the mean, the standard deviation, the range, the moving average, the moving range, and the cumulative sum. Other supported statistical

presentation is required, the next step is to ensure a compatible interface with data acquisition instruments. Ideally, software selection would be made first based on the features and options offered by the selected software vendor. The data acquisition hardware would then be selected based on compatibility with the software.

This approach is not always viable for two reasons. One, the data acquisition hardware may already exist or may already have been purchased. Two, the type of data to be acquired may be specialized in nature and require the use of certain instruments with a limited number of data interface options.

Software programs acquire data by

interfacing to data acquisition hardware, either plug-in cards or stand-alone systems. Communication to plug-in cards is via the computer bus, and communication to standalone systems is via industry standard serial data exchange formats like RS-232, RS-422/485, and IEEE-488. The selected software must be compatible with the data acquisition hardware, or a bridge must be used.

The bridge may be either a software or a hardware solution. A hardware solution accepts inputs from field devices and instruments and converts these inputs into outputs compatible with the selected software. A software solution processes input data and makes these data available to the data presentation and analysis program via a standard dynamic data transfer format such as DDE. 

References & Further Reading

- *The Data Acquisition Systems Handbook*, Omega Press LLC, 1997.
- *New Horizons in Data Acquisition and Computer Interfaces*, Omega Press LLC, 1997.
- *Omega Universal Guide to Data Acquisition and Computer Interfaces*, Omega Press LLC, 1997.
- *The Software Connection*, 97.1 & 97.2, Rockwell Software, 1997.

- Trend Recorders
- Data Loggers
- Videographic Recorders

Recording, Printing & Storage

Once data has been acquired, there is often a need to store it for current and future reference. Today, alternative methods of data storage embrace both digital computer memory and that old traditional standby—paper. Covering in any detail the scores of instruments on the market today for recording, logging, printing, and storage of data is far beyond the scope of this section. The aim here is to identify and define major categories and offer the prospective user some practical guidelines to a selection best suited for the application.

Broadly speaking, there are two principal areas where recorders or data loggers are used:

- Process measurements for such variables as temperature, pressure, flow, pH, humidity; and,
- Scientific and engineering applications such as high-speed testing (e.g., stress/strain), statistical analyses, and other laboratory or off-line uses where a graphic or digital record of selected variables is desired.

Instrumentation for each of these fields can have many operating principles and features in common. Each area, however, may place more emphasis on the importance of such factors as cost, method of use (e.g., benchtop vs. panel mounting), portability, degree of accuracy, speed of response, and number of points (channels) to be measured.

For some time now, digital computer systems have had the ability to provide useful trend curves on CRT displays—displays that could be ana-

lyzed and printed out. Today, a similar approach permits digital inputs to recorders and data loggers to be stored electronically on-board or sent to a remote PC, distributed control system (DCS) workstation, or full-color printer.

There is now a plethora of data acquisition hardware and software that can work with PCs—making it quite plausible to classify them as recorders or, alternatively, data loggers. These are referred to as PC-based solutions.

There remains a continuing role for conventional standalone recorders that still use paper and pen or printer, but here, too, such products have gained greatly in capabilities through advances in electronics and new technologies such as inkjet and laser printing.

New technology has also made paperless, or videographic, recorders

export data to a PC or DCS workstation, in real-time or periodically for later analysis.

The traditional data logger, whose original basic function was to print out digital values of a measured variable versus time, also has benefited from new technology that has added disk or card memory storage and faster logging capabilities. Some can provide real-time recording via network connection to a host system.

In recent years, conventional analog recorders have had the functions of a data logger added to their capabilities. Called “hybrid recorders,” they combine analog trend representations with digital information on the same chart paper.

Scores of specialized software packages are offered not only to implement the PC-based functions mentioned above but also to perform complex mathematical opera-

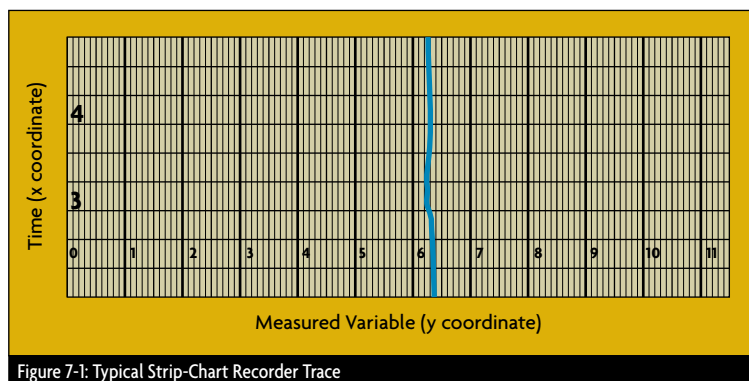

Figure 7-1: Typical Strip-Chart Recorder Trace

a practical reality, with attendant savings in materials and maintenance. This mushrooming class of instruments mimics conventional trend recorder displays; it also has the capabilities of a data logger and can

tions or signal conditioning on input and output data.

For high-speed recording, the traditional analog oscilloscope has also been enhanced by a digital storage version (DSO), which finds an impor-

tant application in test and analysis of today's many electronic products—both consumer and industrial.

The moral of this overview? There are no longer sharp distinctions between many of the products that serve the “front end” of a data acquisition system. In fact, the breakneck evolution of computer and networking technologies will continue to meld alternative offerings for process monitoring, data acquisition, and test and measurement applications.

Definitions & Classifications

The first terminology distinction to draw is that between a recorder and a data logger. Acknowledging that sharp lines no longer exist, consider the fundamental ways in which each type of recording instrument functions to store, analyze, and record data. A traditional recorder accepts an input and compares it to a full-scale value. The recording pen is then moved to a point on the scale that represents a useful value of the input—say, 500°F with a chart range of 0 to 1000°F—at a time that is given by the calibrations on the recorder's moving chart (Figure 7-1).

On the other hand, a data logger accepts an input which is fed into an analog-to-digital converter and stored digitally, or printed out as a series of time-stamped values. Today, many such instruments have some form of on-board intelligence which provides the user with diverse capabilities for signal conditioning as well as data storage and analysis.

As an alternative to a recorder, a data logger can have the ability to accept a greater number of inputs (referred to as channels), with better resolution and accuracy. Only a recorder, however, can provide a truly continuous trend display of the

variable's change with time.

The term graphic recorder more aptly describes the majority of

chart speeds—fixed, once configured—to suit the application. Thus, at 4 (o'clock) in Figure 7-1, an operator



Paper-based recording devices are available in a wide range of configurations.

recorders used in data acquisition systems. It is defined as an instrument which, in some automatic fashion, draws a graph. Such a graph may relate two or more variables to time, or to each other (the latter, typified by an X-Y recorder). “Graphic” is also used widely today in reference to CRT displays, many of which do not qualify as graphs. Graphic coordinates hearken back to basic geometry, where curves are plotted on a rectangular coordinate matrix. The strip-chart recorder, so common in a great variety of forms today, had its origin in this basic concept (Figure 7-1). Note that the vertical coordinate (time) is the X axis of a graph and the horizontal coordinate (measured variable) is the Y axis. The heavy vertical line in the center of the chart is the curve plotted by the recorder (often called the chart record or trace).

Recorders can have adjustable

can see that the temperature was 625°F. He or she can also note that the temperature has remained rather steady. The trend is often as important, or more important, than the precise value. Thus, this type of instrument is often called a trend recorder.

With an X-Y recorder, the time coordinate X is replaced by some other variable, such as stress, plotted versus strain. Other versions of this type may have two different variables, Y and Y' plotted vs. X or have time (t) also as one of the variables.

Circular-chart coordinates (Figure 7-2) were developed early in recorder history to utilize the convenience of a spring-wound clock and synchronous motor movements. Depending on application needs, the circular chart speed can be one rotation in 24 hours, one rotation in a week, or another arbitrary time interval. Note the advantage of a circular chart in giving at a glance a complete history

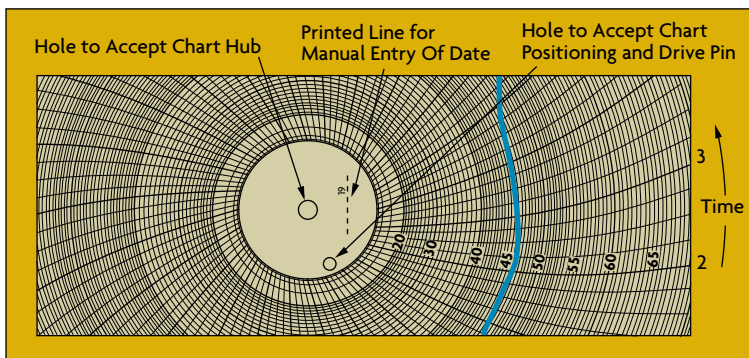

Figure 7-2: Typical Circular Chart Recorder Trace

of one or several variables over a period of time—albeit not with a high-accuracy readings.

Chart sizes are referred to by total diameter, such as 10 inch or 12 inch, although full-scale pen movement is often much less. Because many plant operators are used to reading circular chart recorders, suppliers still find a strong market for them.

From a commercial cataloging standpoint, graphic recorders are generally classified by their common usages or physical appearance, such as strip chart, circular chart, or special purpose (X-Y, event, or oscillographic). A further broad distinction is whether the instrument is flatbed for benchtop mounting or vertical, for panel or rack mounting.

Data loggers, too, can be classified as benchtop units; others are described as panel-mount printers and still others are “vertical” benchtop units. Smaller, handheld units also are available.

As with any method of classification, such names leave gray areas. For example, some flatbed types utilize strip charts and some are vertical. Many data loggers are bench-top, but some are vertical and panel-mounted. And videographic, or paperless recorders can provide

screen displays that look like a strip chart or a circular chart.

Trend Recorders

Vertical strip-chart recorders head this category, embracing many types that are commonly designed for permanent installation and are normally mounted vertically—usually in panel cut-outs for process measurements but also on relay racks as for laboratory measurements. Size is one distinction of this class, with chart widths ranging from 100 mm to 10 inches (250 mm) or more.

Other terms used to describe vertical strip-chart recorders include electronic, hybrid, and multi-point. Certain models can record up to 32 channels, although common designs for process measurements normally do not exceed 12. Instruments in this class are designed to plot variables over long periods of time, utilizing paper take-up rolls or trays for Z-fold paper. Chart speeds, programmable in most cases, normally range from 1 cm/min to 30 cm/min.

This category contains many variations on the basic principle of strip-chart recording shown in Figure 7-1. One extensive catalog reference covers 29 different models; a majority of these are for the measurement of process variables, but there are also

numerous designs customized for scientific and laboratory applications.

The impact of the microprocessor is obvious in many strip-chart recorder models, with digital storage of data points a common advanced feature. Another result of new technology is the ability to handle a variety of variables, such as flow, along with temperature and pressure.

Another result of microprocessor technology is the hybrid recorder, which provides high-speed recording of up to 30 recording channels as well as digital measurement data. On these units, the digital information is sometimes printed on the left margin of the chart in up to six colors. Typically, some form of keyboard on the front panel (or accessible with the door open) is used for programming of chart speed, alarm setpoints, full-scale range, and other features.



Flatbed recorders offer a portable, flexible alternative to permanently mounted units.

Some of the features of strip-chart process recorders can include:

- 1 to 4-pen continuous writing and up to 24-point dot printing;
- Memory card for recorder setup and data storage; and,
- Digital display, horizontal bar graph, and digital totalizer for each channel.

In large case, 250-mm recorders, additional features may include:

- Interactive, menu-driven programming;
- Trend printing with user-assignable colors; and,
- Ability to print up to 60 analog input channels.

Flatbed and portable versions also are available, more suited for laboratory or test uses. Some include signal input modules which plug into compartments on the recorder so that, for example, they can accommodate the direct input from a thermocouple. Some models have as many as six such plug-in input modules and are referred to as modular recorders.

One recorder with a capability to handle 1,600 samples/second employs a thermo-array recording system, with 200 dots per inch (dpi) resolution on a 200-mm wide thermally sensitive chart. Referred to as therographic recording, this method uses a linear array of fixed thermal-printing elements (stylii) across the chart width. A heated stylus affects the heat sensitive paper to produce the chart record. The chart grid system is generated by the printer.

A portable, benchtop model that handles 10 or 20 channels uses a printing technique described as raster scan. With this printing method, the recorder can handle high-speed scanning of 20 points/second and high-speed recording of 50 points/second.

A highly-specialized “transient”

recorder with a 170-mm wide thermally sensitive paper chart is offered to record signals for which standard recorders are too slow. It offers digital sampling and storage up to 1 MHz. It

fiber-tipped, disposable cartridges. Chart width is typically 100 mm; larger models range from 200 to 250 mm. Notable is the instrument’s speed—typically 0.4 seconds full-



Many trend recorders include a digital display of the variable in question as well as a long term paper record.

has a modular design that allows expansion to 30 channels. Its 16 K memory per channel can store up to 16,000 samples and its standard analog output can directly interface to an oscilloscope or strip-chart recorder.

• **Flatbed Recorders**

For testing and other laboratory work, flatbed recorders are offered with a variety of switch-selectable, full-scale ranges to accommodate different inputs. Designed to meet various application needs, they typically offer a range of chart speeds from centimeters/minute to centimeters/hour. A typical slow speed is 1 cm/hr; a fast speed generally is 60 cm/min.

Most flatbed recorders, including X-Y types, record with ink, using

scale response for this class.

Offerings in various flatbed models include:

- Ability to accept a variety of inputs, such as from thermocouples and RTDs, ac/dc voltage/current, and relative humidity—with available inputs depending on the model;
- Two and three pens with pen offset compensation. (One model has four channels with a choice of display modes: measured data, bar graph, or range data);
- Widely adjustable chart speeds. One portable, battery-operated model for recording temperature and relative humidity comes with chart paper pre-printed for chart capacity of 1, 7, and 32 days;
- Built-in 3.5-in. digital (LCD) display (on a one-channel model)

indicating true value of input;

- Protocol printing on chart to permanently record measurement range, chart speed, etc.;
- Built-in remote control of paper advance, pen lift (automatically lifts the pen after 30 seconds if chart is not advancing), and event marker; and,
- One model type, called a “function recorder,” is offered with up to three channels, each of which can have its own plug-in input module to equip the recorder for specific inputs types.

More sophisticated units add RS-232 serial or IEEE-488 parallel computer interface to handle data output and remote configuration, 3.5-in. disk drive for data logging, and digital data print-out.

• **XY Recorders**

XY recorders, though usually flatbed in design, are really a class by themselves. Most employ a potentiometric pen-positioning system, but some newer models feature a digital servo system. The instrument’s basic function is to plot the relationship of two input variables with no regard for time. Input signals to the recorder can be analog or digital, with suitable conditioning as required. Common sizes for the chart paper are 8.5 by 11 and 11 by 17 inches.

In addition to features as described above for flatbed recorders, options available in certain X-Y recorders include:

- Ability to also plot either the X or Y inputs versus time. Such a capability is expressed as X-Y, Y-t and X-t recording. The mode to be used is selectable on the instrument’s front adjustment panel.
- An additional servo-actuated measuring element and recording pen

yields an XX’Y or YYY’ recorder that can plot the relationship among three variables.

- To distinguish different chart records plotted on the same chart, one design with a digital plotter can use eight different color pens (disposable felt tipped). Pen change is selected manually or via RS-232C interface.
- Recorder responsiveness is expressed in a “slewing” speed along each axis. The speed may be, say, 0.6

thermal-array recorders include a memory X-Y mode, so that the user can capture high-speed transients for later X-Y replay.

• **Circular Chart Recorders**

Basic characteristics of this type of recorder were covered with reference to Figure 7-2. In this class, too, the microprocessor has had its beneficial effects. Recent developments include circular chart recorders that use blank circular chart paper, printing the

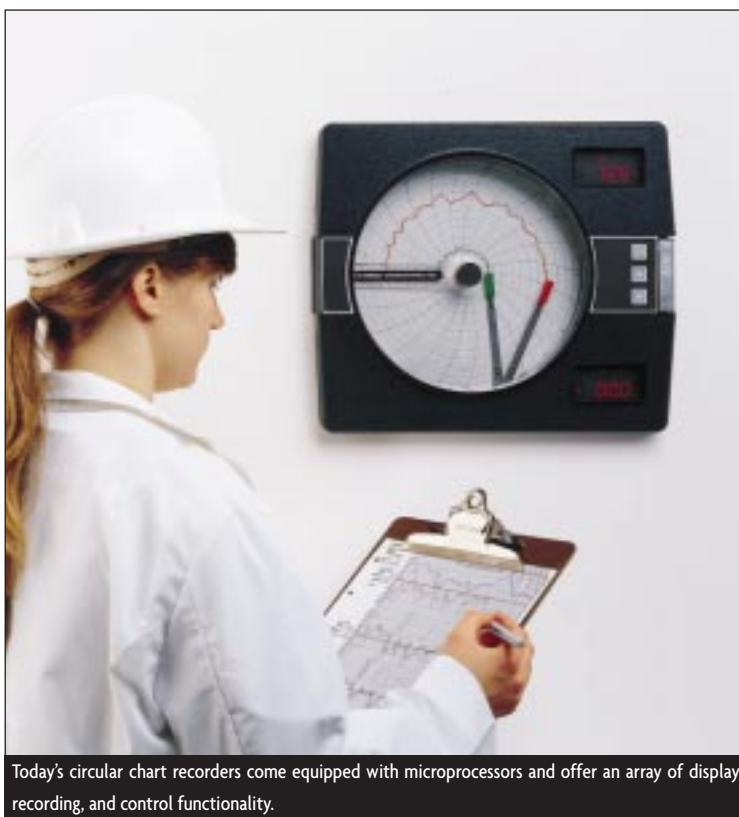

Today’s circular chart recorders come equipped with microprocessors and offer an array of display, recording, and control functionality.

meter/second for the X-axis and 0.8 m/s for the Y-axis.

Some thermal-array recorders also include an X-Y recording mode. Such instruments offer much higher real-time frequency response and the ability to print many Y channels against a single X channel. Some

scales and traces for up to four channels, as recording progresses.

One of the newer types uses heat-sensitive paper on which a single stylus printhead produces up to four analog traces and also prints alphanumeric chart data and time lines. The instrument is user configurable via English

language prompts. Another unit can be programmed to print the equivalent of 10-inch, 11-inch, or 12-inch diameter charts. It is fully configurable from a PC or a keypad and prints straight time lines (not curved, as conventional recorders have used for many years).

Other capabilities that the micro-processor has brought to the circular-chart recorder include:

- Ability to handle a variety of inputs such as all common types of thermocouples, RTDs, dc voltages and currents;
- Control outputs (including PID) and adjustable alarms settings;
- Flow totalization, including data logging of totals; and
- Retransmission options.

One model, custom-designed for measuring and recording temperature and relative humidity, uses a double-sided, 200-mm (8-inch) chart. Available chart capacities are 1, 7, or 32 days. Here again, an embedded microprocessor affords capabilities such as digital display with user-selectable read-out of temperature in °F or °C, relative humidity, and alarm setpoints.

Data Loggers

Based upon the way data is recorded and stored, there are two types of standalone data loggers. One type stores the data in memory to be retrieved at a later time; the other type automatically records the data on paper for immediate viewing and analysis. Many designs combine these two functions, with one or the other of primary importance

The discussion here is confined to various types of standalone units. In addition, there is a wide variety of software packages that can be loaded into PCs, DCSs, or other computer-based devices to provide

excellent data-logging and digital data storage capabilities.

Note, too, that hybrid recorders, as mentioned earlier, serve many of the functions formerly reserved for a separate data logger. Conversely,

contents and format of print-out, configuration of each channel, high and low alarms, and much more.

- Two-way communication via RS-232 serial port—for programming inputs and data outputs via a



This portable data logger handles up to 16 channels and can download data to Windows-based programs for later analysis.

modern data loggers also can provide visual displays and digital read-outs. They also can perform complex mathematical operations on incoming data.

Functional highlights of a typical programmable, multi-functional data logger include:

- Automatic measurement, digital display, recording (storage), and printing of data from a variety of inputs (e.g. thermocouples of different types and voltage sources).
- Wall, panel, and bench-top configurations.
- Programmable parameters including date and time, print interval,

remote PC or other system.

- Optional alarm boards with high and low relays for each channel.
- Built-in thermal printer with external trigger control.
- Data cache with buffer.
- Graphical software for an associated PC.

Not all standalone units, of course, offer all such features. Some are smaller and more portable, using built-in memory to store data for later review. These usually include an RS-232 serial port for data download and a digital display.

Some models are battery-operated for easy portability in field applica-

20 QUESTIONS IN RECORDER SELECTION

Given the wide variety of instruments for recording or logging acquired data, the prospective user needs to review the key factors involved in making a suitable selection. To help, here are some key questions and basic points to consider:

- 1) How many inputs are to be recorded or logged? These are often called channels, points, or records.
- 2) What types of inputs are involved? Voltages, T/C or RTD, 4-20 mA.
- 3) Do different input types need to be handled by the same unit?
- 4) What type of recording or logging is required—continuous single-point or multi-point? And if the latter, what minimum scan cycle is required?
- 5) What degree of accuracy is required? Accuracy may be defined as the closeness to the actual signal that the measured value or trend position takes—stated in either a plus/minus percentage of full scale or percentage of reading.
- 6) Is a communication interface required to transmit measured data to a host computer? Set up the instrument remotely? Connect to an external printer?
- 7) Is the instrument to be mounted bench-top or in a panel?
- 8) What type of instrument power is available?
- 9) Is log-type recording desired instead of or in addition to continuous trend recording?
- 10) Is color differentiation desirable for multiple trend lines?
- 11) If the instrument is to perform alarm functions, how many alarm setpoints are needed per channel? What types of alarms are desired—e.g. threshold, rate, or delta? Are relays contacts required to handle external alarm outputs? If so, how many?
- 12) What, if any, signal processing is required? These may include linear scaling (conversion to engineering units), thermocouple characterization, difference calculation, square root calculation (as for an orifice flowmeter).
- 13) Are any higher-level math functions required? These may include absolute value, logarithm, exponential, maximum, minimum, time average, group average, summation, standard deviation, and integration functions.
- 14) For conventional, paper-based recorders, what writing method is preferable? Capillary ink? Disposable felt-tip ink cartridge? Dot printing, using an ink ribbon cassette or pressure sensitive paper? Thermal moving head or stationary linear array? Rotating ink wheel?
- 15) If a strip-chart recorder is used, is a Z-fold or roll type of chart desired? Z-fold has become the primary choice for process applications because of the ease with which an operator can review past traces without disrupting active recording.
- 16) Should the chart speed be fixed or programmable?
- 17) What kinds of annotations on the chart are desired? Tags, lists, engineering units, messages, scales, channel identification (numeric or alphanumeric), date and time, chart speed, and instantaneous, “snapshot” values. Continuous writing instruments provide the annotation by a separate printhead.
- 18) For a strip-chart recorder, what chart width is desired—100 mm, 180 mm, or 250 mm, other?
- 19) What secondary visual indications are desired? Analog bar graph in percentage of full scale? Analog scale indication in percentage of full scale? Digital channel (point) number and measured value? Alarm status? Engineering units?
- 20) What operating modes will be required? Options include normal monitoring, which involves monitoring at a set scan interval and trend recording at a set chart speed, or logging at set intervals; print on alarm, which involves monitoring at a set scan interval but not trend recording or logging until an alarm condition occurs; and change on alarm, which allows tending or logging at a base chart speed or log interval when no alarm condition exists and an automatic switch to an alternate (usually faster) chart speed or log interval when an alarm condition exists.

tions. One variation is a self-contained unit that can, for example, profile temperatures as it passes through an in-line bake oven.

Oscillographic Recorders

Used primarily for applications in the test and research fields, the capabilities of oscillographic recorders and the newer digital oscilloscopes have expanded greatly over the past several years. An oscillograph is a device for determining waveforms by plotting instantaneous values of a quantity such as voltage as a function of time. A decade ago, this implied either a recording galvanometer or a CRT recorder—analog instruments that afforded the needed bandwidths in excess of 20 kHz.

As in other recorder developments, however, digital is the buzzword today and digital storage oscilloscopes (DSOs) or simply digital oscilloscopes have proliferated. These may be defined as oscilloscopes that digitize an input signal for storage in memory for later display or analysis. It is a logical and relatively simple step to use the stored data to provide a chart record, and many DSOs do just that, essentially acting as data loggers.

A recent survey lists some 30 different suppliers of DSOs, many of them PC-based. They cover a range of bandwidths—some around 40 to 50 MHz while others go as high as 350 MHz. These are sophisticated electronic instruments that have capabilities far beyond traditional analog CRT-based oscilloscopes, which have been around for many decades.

• **Analog Oscilloscopes**

An early form of oscillograph, also called a “light-beam recorder” uses a mirror connected to the rotating

armature. An input voltage causes a degree of armature rotation which, in turn, moves the mirror a proportionate amount. A light source, usually ultraviolet, is reflected off the mirror onto a light-sensitive paper which moves at a fixed chart speed like a strip-chart recorder. The result is a series of light spots (data points) on the recording chart. Frequency response of this device is some 25,000 Hz.

A step in the advancement of recording analog oscilloscopes is the CRT-based instrument. These instruments can display not only instantaneous values of voltage vs. time, but using suitable input transducers, can convert other variables—such as current, strain, acceleration, and pressure—into voltage for display on a CRT.

The CRT display is a graphical representation of electrical signals produced by varying the position of a focused spot where an electron beam strikes the fluorescent (phosphor) coating on the inside surface of the CRT face. This type of oscilloscope over the years has benefited from advances in solid-state, semiconductor electronics, as well as improvements in phosphors which are also used today for CRTs in other applications. In fact, some CRT-based terminals and workstations are, in essence, highly-sophisticated oscilloscopes.

One typical fiber-optic DSO can be adapted to record over 30 channels. Records that are relatively insensitive to normal room light are produced by ultraviolet light generated by the CRT. The UV light is directed through a special CRT fiber-optic faceplate onto photosensitive direct print paper.

The CRT faceplate consists of millions of tiny glass fibers, fused together within a 5- by 200-mm

(0.2 - by 8-inch) area. These fibers are the means for transfer of ultraviolet light from the phosphor inside the faceplate to the photosensitive recording paper—enhancing writing speed and trace resolution.

Note that the recorder has four axes: an X axis (time base or horizontal), Y axis (amplitude or vertical), Z axis (spot intensity), and Y axis (movement of recording medium). The four axes provide an instrument that is very versatile. For example, video pictures from television or facsimile can be recorded by use of the Z-X axes, together with either the Y or Y axis. The quality of the pictures will depend on such factors as sensitivity of the recording medium, bandwidth of the Z-axis amplifier, and the spot size that can be recorded.

• **Oscilloscope Selection**

There are many technical details in oscillographic recorder or digital

oscilloscope designs that can only be highlighted here. Some of the terms used in evaluating and selecting one type versus another are:

- **Bandwidth:** In data communications, this term means the difference between the highest and lowest frequencies of a transmission channel. With oscilloscopes, it is expressed in MHz. One supplier defines bandwidth as the maximum frequency that a scope can capture without reducing the amplitude by more than 3 dB. Generally, the greater the bandwidth, the more waveform information can be sent through in a given time. With such increases, however, can come an increase in cost and complexity. DSOs can have a bandwidth as high as 500 MHz at a relatively low cost, whereas similar performance in an analog unit is not readily available.
- **Trigger Capability:** Triggering the device means initiating the measuring



Extremely compact, battery-powered data loggers can even ride along through a process for accurate temperature and humidity profiling.

function at appropriate times versus having the instrument running all the time. Flexibility of the device in triggering extends its ability to capture, for example, any aberrations that occur on a signal or group of signals.

- **Mode of Operation:** An analog oscilloscope is best for displaying signals with high information content, such as video. This is due to its high real-time screen update characteristic. On the other hand, a storage

twice as fast as the highest frequency content of the signal, therefore the user must always be conscious of having enough sampling points to reconstruct the waveform accurately.

- **Memory Length:** This is the number of samples that a DSO takes each time a waveform is captured.

- **Vertical Resolution:** In a DSO this is the number of digitizing levels from the A/D converter; 8-bit resolution gives 256 steps and 12-bit

that the user switch to analog mode if there is any doubt about a waveform's true characteristics.

There are other reasons for using analog oscilloscopes, but DSOs offer three capabilities which lead to their preference in many applications. These include the ability to capture and display very slow signals, the conversion of signals into digital form for further analysis, and the ability to more easily handle higher bandwidths.

In short, today's digital oscilloscopes are marvels of modern, state-of-the-art technology—offering test and research technicians and engineers extremely versatile tools.

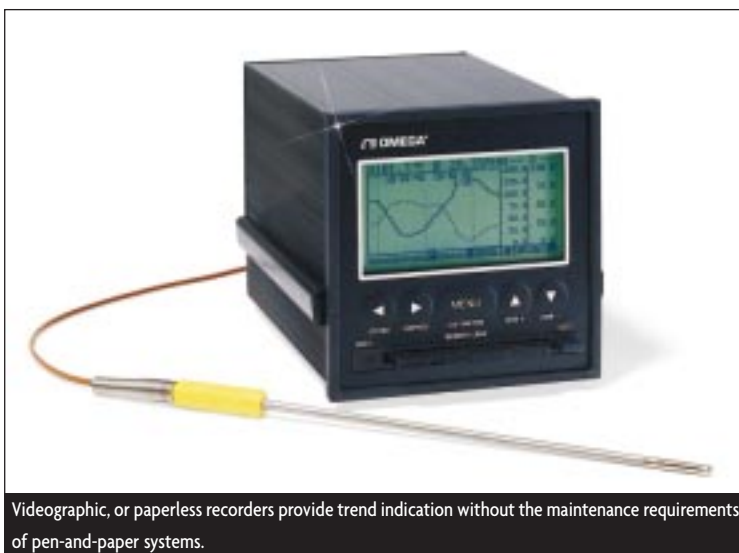

Videographic, or paperless recorders provide trend indication without the maintenance requirements of pen-and-paper systems.

oscilloscope may be better suited for transients, alphanumeric display, curve traces, etc.

- **Analog and Digital Storage:** Several manufacturers offer oscilloscopes that combine both analog and digital storage in one unit. The display flexibility this affords is well suited to general purpose applications, from single use to complex signal handling.

- **Sampling Rate:** In a DSO, this is the maximum speed at which the analog-to-digital converter samples the incoming waveform. It is usually specified in millions of samples per second (MS/s). The Nyquist theorem states that a signal must be sampled at least

resolution gives 4,096 steps.

- **Interface for Remote Control:** Most DSOs have interfaces (IEEE-488 or RS-232C) that allow them to be remotely configured and controlled.

A basic characteristic of an analog scope is the variable intensity of the displayed trace. Changes in trace brightness and line width result from the fact that light emission from the CRT phosphor coating is proportional to the speed of the electron beam exciting it. Operators have learned to interpret and rely upon intensity variations to the extent that some manufacturers of combined analog and digital oscilloscopes recommend

Videographic Recorders

Evidence of the many benefits of videographic, or paperless, recorders are the large number of suppliers that now offer these types of instruments. Some are relative newcomers to the recorder field, utilizing their expertise in electronic technology to meet user needs. One example is the recent offering of a circular chart videographic recorder with a 10-inch screen display—equivalent in size to the common paper chart versions.

Display technology has been getting better and better in sharpness of detail, with a wide range of bright colors, similar to the proven quality of a newer PC. Some models offer the flexibility of plotting records horizontally or vertically. A common screen size on such recorders is small—on the order of 76 mm wide by 38 mm high (3 in. x 1.5 in.).

Some suppliers offer a 5-inch wide display area or larger. Most are designed for panel mounting and come in a size as small as 1/4 DIN. In addition to displaying trend records or bar graphs, the instruments can be

configured at will to provide large digital displays of the measurements in engineering units or small digital readings along with the trend curves.

These recorders have some form of storage media—either a 3-1/2 inch floppy disk or a PCMCIA card—which continuously stores all the measurement inputs as well as the recorder configuration. From such stored data, an operator can use a touchscreen or membrane keypad to provide such



Magnetic storage media, on PCMCIA card or floppy disk, allow videographic recorders to download data for archival storage.

display functions as: a split screen (two trend windows), zooming, face-plate displays, alarm summaries, and selected trends (such as six out of up to 24 inputs).

The recorder's disk or card can be removed and used to download all its accumulated data to a PC that has the necessary software. An engineer can bring up any of the stored data for review and analysis, zooming in on a desired time, say, of a process upset (as well as just before and just after the event).

Videographic recorders may include a serial port that permits data to be sent, for example, over an RS-422/485 communication network directly to a

PC or DCS with suitable software. This can be two-way communication. Thus, an operator at a PC in a control room

could monitor the recorder readings in real-time, call for specific data, and even reconfigure the recorder. T

References and Further Reading

- *The Data Acquisition Systems Handbook*, Omega Press LLC, 1997.
- *New Horizons in Data Acquisition and Computer Interfaces*, Omega Press LLC, 1997.
- *Omega® Universal Guide to Data Acquisition and Computer Interfaces*, Omega Press LLC, 1997.
- "Boards, Recorders, and Software Ease Data Acquisition, Temperature Recording Tasks," Peter Cleaveland, *I&CS*, August, 1997.
- *Dictionary of Measurement and Control: Guidelines for Quality, Safety, and Productivity*, 3rd ed., ISA, 1995.
- "DSO—Digital Storage Oscilloscopes," T. Lecklider, et al, *Measurements & Control*, October, 1996.
- *Encyclopedia of Instrumentation and Control*, Douglas M. Considine, McGraw-Hill, 1971.
- *Instrument Engineers' Handbook, Third Edition*, Bela G. Liptak, Chilton, 1995.
- *Instrumentation Catalogue, Measurement and Automation*, National Instruments, 1998.
- "Melding Markets Via Evolution," M.P. Minneman and W. H. Manning, *InTech*, February, 1997.
- "Monitoring and Data Collection Improved by Videographic Recorder," *Water Engineering & Management*, November, 1995.
- "New Breed of Industrial Process Recorder," Collen Baker, *Measurements & Control*, September, 1996.
- "Oscilloscopes—DSO Versus Analog," Richard Parish, *Measurements & Control*, September, 1997.
- "Paperless Recorders Meet Expanding Information Needs," Greg Kleinert, *I&CS*, March 1995.
- "Paperless: The Trend in Recording," John Ham, *InTech*, June 1996.
- "Portable Multifunction Paperless Data Loggers," Ed Palko, *Plant Engineering*, September, 1995.
- "Power Analysis with a DSO," Kevin J. Cassidy, *Measurements & Control*, October, 1997.
- *Process/Industrial Instruments and Controls Handbook, Fourth ed.*, Douglas M. Considine, McGraw-Hill, 1993.
- "Process Recorders Keep Getting More Flexible and Capable," *Control Engineering*, September, 1996.
- "Recent DSO Developments," Charles Holtom, *Measurements & Control*, October, 1996.
- "Regulators Embrace Paperless Recorders," Phil Shook, *Control*, April 1995.
- "Smarter, Faster, Data Logging Systems," Steve Lekas, *Sensors*, October, 1997.
- "Videographic Recorders," Brian Mattox and Patrick Bridge, *Measurements & Control*, September, 1997.
- "X-Y Recorders," *Measurements & Control*, October, 1997.

Information Resources

ORGANIZATIONS

NAME/ADDRESS	PHONE	WEB ADDRESS
American Institute of Chemical Engineers (AIChE) 345 East 47 Street, New York, NY 10017-2395	212/705-7338	www.aiche.org
American National Standards Institute 11 West 42nd Street, New York, NY 10036	212/642-4900	web.ansi.org
American Society for Quality P.O. Box 3005, Milwaukee, WI 53201-3005	414/272-8875	www.asqc.org
American Society of Mechanical Engineers (ASME) 345 East 47th Street, New York, NY 10017	212/705-7722	www.asme.org
American Statistical Association 1429 Duke Street, Alexandria, VA 22314-3415	703/684-1221	www.amstat.org
Electric Power Research Institute (EPRI) 3412 Hillview Avenue, Palo Alto, CA 94303	415/855-2000	www.epri.com
Electronic Industries Association 2500 Wilson Boulevard, Arlington, VA 22201-3834	703/907-7500	www.eia.org
Federal Communications Commission 1919 M Street N.W., Washington DC 20554	888/225-5322	www.fcc.gov
Fieldbus Foundation 1998 Fieldbus Foundation 9390 Research Blvd., Ste. II-250, Austin, TX 78759	512/794-8890	www.fieldbus.org
Institute of Electrical & Electronics Engineers 445 Hoes Lane, Piscataway, NJ 08855-1331	732/981-0060	www.ieee.org
International Organization for Standardization (ISO) 1, rue de Varembe, Case postale 56 CH-1211 Genève 20, Switzerland	+ 41 22 749 01 11	www.iso.ch
ISA—The International Society for Measurement & Control 67 Alexander Drive, Research Triangle Park, NC 27709	919/549-8411	www.isa.org
National Institute of Standards & Technology Gaithersburg, MD 20899-0001	301/975-3058	www.nist.gov
OPC Foundation P.O. Box 140524, Austin, TX 76714-0524	512/834-7200	www.opcfoundation.org
Profibus Trade Organization 5010 East Shea Blvd., Suite C-226, Scottsdale, AZ 85254-4683	602/483-2456	www.profibus.org

**For the Latest
Information on
Data Acquisition
Products:**

Omega Engineering, Inc.
One Omega Drive, P.O. Box 4047, Stamford, CT 06907-0047
Phone: 800-82-66342 (800-TC-OMEGASM)
Email: info@omega.com
Website: www.omega.com



OMEGA PRESS REFERENCES

The Data Acquisition Systems Handbook,
Omega Press LLC, 1997.

New Horizons in Data Acquisition and Computer Interfaces,
Omega Press LLC, 1997.

Omega® Universal Guide to Data Acquisition and Computer Interfaces,
Omega Press LLC, 1997.

Book of Books®: Scientific & Technical Books, Software & Videos,
Omega Press 1998.

OTHER REFERENCE BOOKS

Activex Programming Unleashed,
Weiyung Chen (editor), Sams, 1996 Weiyung Chen, Sams, 1996.

Analog and Digital Communication Systems,
Martin S. Roden, 1995.

Analog and Digital Signal Processing,
H. Baher, John Wiley & Sons, 1990.

Analog and Digital Signal Transmission,
Lawrence M. Thompson, ISA, 1985.

Analog I/O Design: Acquisition, Conversion, Recovery,
Patrick Garrett, Reston Publishing Co., 1981.

Analog Signal Processing and Instrumentation,
Arie F. Arbel, Cambridge University Press, 1980.

Analog-Digital Conversion Handbook,
Analog Devices, Inc., Prentice Hall, 1985.

Analog-To-Digital and Digital-To-Analog Conversion Techniques,
David F. Hoeschele, John Wiley & Sons, 1994.

Analog-To-Digital Conversion: A Practical Approach,
Kevin M. Daughtery, McGraw Hill, 1995.

Automation Systems for Control and Data Acquisition,
Lawrence T. Amy, ISA, 1992.

Beginning Java,
Ivor Horton, Wrox Press, Inc., 1997.

Business Data Communications, Fourth Edition,
D. A. Stamper, Benjamin/Cummings, 1994.

Computer Interfacing: A Practical Approach to Data Acquisition and Control,
William H. Rigby and Terry Dalby, Prentice Hall, 1994.

Computer Networks, Second Edition,
A. S. Tanenbaum, Prentice Hall, 1988.

Concise Encyclopedia of Software Engineering,
Derrick Morris and Boris Tamm (editors) Pergamon Press, 1993.

Data Acquisition and Control, Microcomputer Applications for Scientists and Engineers,
Joseph J. Carr, Tab Books Inc., 1988.

Data Acquisition and Process Control Using Personal Computers,
Tarik Ozkul, Marcel Dekker, 1996.

Data Acquisition Techniques Using Personal Computers,
Howard Austerlitz, Academic Press, 1991.

Data Communications—Video and Workbook,
Industrial Training Corp. for ISA, 1993.

Data Communications, A Beginner's Guide to Concepts and Technology,
Scott A. Helmers, Prentice-Hall, Inc., 1989.

Data Communications, Computer Networks and Open Systems, Fourth Edition,
F. Halsall, Addison-Wesley, 1996.

Dictionary of Measurement and Control: Guidelines for Quality, Safety, and Productivity, 3rd ed.,
ISA, 1995.

Digital Control Systems: Theory, Hardware, Software,
Constantine Houpis and Gary Lamont, McGraw, 1991.

Distributed Operating Systems: Concepts and Design,
Pradeep K. Sinha, IEEE, 1996.

Distributed Systems—Concepts and Design, Second Edition,
G. Coulouris, J. Dollimore, & T. Kindberg, Addison-Wesley, 1994.

Encyclopedia of Instrumentation and Control,
Douglas M. Considine, McGraw-Hill, 1971.

Essential Visual Basic 5.0 Fast,
John R. Cowell, Springer Verlag, 1997.

The Essential Windows NT Book,
Richard Cravens, Prima Publishing, 1996.

GUI Design for Dummies,
Laura Arlov, IDG Books, 1997.

Guide to Networking and Internetworking Terms,
P. Simoneau, American Research Group, 1994.

How Networks Work,
F. J. Derfler, Jr. and L. Freed, Ziff-Davis Press, 1993.

Instrument Engineers' Handbook, Third Edition,
B. Liptak (editor), Chilton Book Co. (CRC Press), 1995.

Introduction to Analog and Digital Communications,
Simon Haykin, John Wiley & Sons, 1989.

The Java Programming Language,
Ken Arnold and James Gosling, Addison-Wesley, 1997.

The McGraw-Hill Encyclopedia of Science and Technology, 8th ed., Vol. 9,
McGraw-Hill, 1997.

Microcomputer Interfacing and Applications,
A. Mustafa, Butterworth-Heinemann, 1994.

Microsoft Windows NT Workstation 4.0: At a Glance,
Jerry Joyce and Marianne Moon, Microsoft Press, 1997.

Microsoft Windows NT Workstation 4.0 Starts Here,
Microsoft Press Interactive, 1997.

Modern Digital and Analog Communication Systems,
B.P. Lathi, Holt, Rinehart, & Winston, 1983.

Modern Operating Systems,
Andrew S. Tannenbaum, Prentice Hall, 1992.

Object-Oriented Software for Manufacturing,
S. Adiga, Chapman & Hall, 1992.

PC Bus Performance Brief: PC Bus Overview,
Intel Corp., 1997.

PC Interfacing for Data Acquisition and Process Control,
Sanjay Gupta and J.P. Gupta, ISA, 1995.

Process/Industrial Instruments & Controls Handbook, Fourth Edition,
Douglas M. Considine, McGraw-Hill Inc., 1993.

Signal Conditioning & PC-Based Data Acquisition Handbook:
A Reference on Analog & Digital Signal Conditioning for PC-Based Data Acquisition,
Steve Lekas, IOtech, Inc., 1997.

Simplified Design of Data Converter,
John D. Lenk, Butterworth-Heinemann, 1997.

Teach Yourself C++ in 21 Days,
Jesse Liberty, Sams Publishing, 1997.

Technical Overview: Foundation Fieldbus,
Fieldbus Foundation, 1996.

What Is PC/104?,
PC/104 Consortium, 1994.

Glossary

A

Accuracy: Closeness of a reading or indication of a measurement device to the actual value of the quantity being measured.

ActiveX Control (OLE Control): Custom control applet based on Microsoft's OLE architecture. Can run in any OLE-enabled container application or web browser.

Address: Label or number identifying the memory location of a unit of information.

Alias: A false lower frequency component that appears in sampled data acquired at too low a sampling rate.

Alphanumeric: A character set containing both letters and digits.

Alternating current (ac): An electric current that reverses its direction at regularly recurring intervals.

Ambient compensation: The design of an instrument such that changes in ambient temperature do not affect the readings of the instrument.

Ambient temperature: The average or mean temperature of the surrounding air in contact with equipment or instruments under test.

American National Standards Institute (ANSI): The United States standards body responsible for designating standards developed by other organizations as national standards.

American Standard Code for Information Interchange (ASCII): Standard seven or eight-bit code used to represent alphanumeric characters for communication among computers.

Ampere (amp): A unit used to define the rate of flow of electricity (current) in an electrical circuit; units are one coulomb (6.25×10^{18} electrons) per second. Symbolized by A.

Amplifier: A device that magnifies an input or output signal using power drawn from a source other than the signal itself.

Amplitude flatness: A measure of gain consistency of a circuit over a range of frequencies.

Amplitude: A measurement of the distance from highest to lowest excursion of a variable or physical motion. Often used with reference to waveforms.

Analog trigger: A trigger that occurs at a user-selected point on an incoming analog signal. Can be set to occur at a specific level on either an increasing or a decreasing signal (positive or negative slope).

Analog-to-digital (A/D): Generic term referring to the conversion of analog information to the digital language of computers.

Analog-to-digital converter (ADC): An electronic device that converts analog signals to an equivalent digital form.

Application program: Computer program designed to accomplish a specific task, such as word processing.

Application-specific integrated circuit (ASIC): Custom semiconductor component designed and manufactured to perform a set of specific functions, typically for a single application.

ARCnet: Token-passing network technology in which nodes "take turns" talking according to which node has the token.

Arithmetic logic unit (ALU): The part of a digital processing system where binary data is operated upon mathematically.

Asynchronous: An event that occurs at an arbitrary time, without synchronization to a reference clock. May refer to network messaging, in which a node sends a message without waiting for the receiver to signal that it is ready to receive.

B

Backbone: High capacity network designed to provide high bandwidth for corporate communication requirements.

Backplane: Multi-conductor assembly into which computer-based boards are inserted. Typically supplies power and allows boards to communicate at high speeds.

Base address: A memory address that serves as the starting address for programmable registers.

Baud rate: Serial communications data transmission rate expressed in bits per second (bps).

Bipolar: A signal range that includes both positive and negative values (i.e., -10 to +10 V).

Bit (b): A single binary digit, valued as either 0 or 1.

Block: A high-speed data transfer in which the address of the data is sent followed by a specified number of back-to-back data words.

Breakdown voltage: Threshold voltage at which circuit components begin to be damaged. See also "working voltage."

Burst mode: High-speed data acquisition mode in which data points are measured as quickly as possible then held for subsequent conversion. Helps reduce skew.

Bus master: A type of a plug-in board or controller with the ability to read and write to devices on the computer bus.

Bus: Group of conductors that interconnect individual circuitry in a computer. Examples of PC buses include ISA, EISA, and PCI.

Byte (B): Eight related bits of data, an eight-bit binary number. Also used to denote the amount of memory required to store one byte of data.

C

Cache: High-speed processor memory that buffers commonly used instructions or data to increase processing throughput.

Calibration: The process of adjusting an instrument or compiling a deviation chart so that its reading can be correlated to the actual value being measured.

Central processing unit (CPU): Microprocessor that functions as the primary computational “brain” of a PC or other computer-based device.

Code width: Smallest voltage an A/D converter can detect; a function of resolution, gain, and range.

Cold junction compensation (CJC): The referencing of thermocouple voltage outputs to ambient temperature in a thermocouple measurement circuit.

Carrier sense multiple access with collision detection (CSMA/CD): Non-deterministic networking scheme in which any node can send messages at any time. Collisions are detected and messages resent as needed.

Common-mode range: Input range over which a circuit can handle a common-mode signal.

Common-mode rejection ratio (CMRR): Measure of an instrument’s ability to reject interference from a common-mode signal, usually expressed in decibels (dB).

Common-mode signal: Mathematical average voltage, relative to a computer’s ground, of the signals from a differential input.

Compiler: Software utility that converts code from a high-level programming language, such as C or Visual Basic, into a machine language. Compiled programs run 10 to 1,000 times faster than interpreted programs. See also Interpreter.

Component Object Model (COM): Underlying Microsoft software architecture that allows applications to be readily integrated.

Component software: Object-oriented software approach in which standalone objects, or components, can readily interact in a container environment without custom program development.

Controller Area Network (CAN): A serial bus developed by Bosch for use in automotive in-vehicle communications. With added communication layers, is the foundation of DeviceNet industrial automation protocol.

Conversion time: Time required to convert an analog or digital signal into its converse.

Counter/timer: Circuit that counts external or clock pulses.

Crosstalk: Unwanted signal on one channel due to interference from another channel.

Current drive capability: Amount of current a digital or analog output channel is capable of sourcing or sinking while still operating within voltage range specifications.

Current sink capability: Ability of a data acquisition board to dissipate current for analog or digital output signals.

Current source capability: Ability of a data acquisition board to supply current for analog or digital output signals.

Current: The rate of flow of electricity. The unit is the ampere (A), which equals one coulomb per second.

D

Data acquisition (DAQ): The activity of measuring, transmitting, and recording electrical signals from sensors, switches, and transducers. Often implies the conversion of these signals into computer-compatible digital information.

Data communications equipment (DCE): Generic telecommunications term referring to the equipment used to actually communicate messages among data terminal equipment (DTE).

Data terminal equipment (DTE): Generic telecommunications term referring to a computer-based device that needs to communicate, also referred to as a generator or receiver. See also Data communications equipment.

Decibel (dB): Unit for expressing a logarithmic measure of the ratio of two signal levels.

Degree: An incremental value in a temperature scale.

Derivative control: Control action in which output correction is proportional to the rate of change of the error signal. Derivative control anticipates the magnitude difference between the process variable and the setpoint.

DeviceNet: Non-proprietary device-level networking protocol for industrial automation. Developed by Allen-Bradley based on Bosch’s CAN chips, now the province of the non-profit Open DeviceNet Vendors Association. (ODVA).

Differential input: Analog input consisting of the volt-

age difference between two terminals, both of which are different from computer ground.

Digital input/output (DIO): Input or output points allowed only two discrete states, typically on or off, 1 or 0.

Digital signal processing (DSP): The manipulation of signal information while it exists in digital rather than analog form.

Digital-to-analog converter (D/A): Electronic device, often an integrated circuit, that converts a digital number into a corresponding analog voltage or current.

Digital-to-analog: Generic term referring to the conversion of digital data to a corresponding analog voltage or current.

DIN: German agency responsible for setting engineering and dimensional standards.

Direct memory access (DMA): Method by which data can be rapidly transferred to or from computer memory without the processor's intervention.

Distributed control system (DCS): Typically a large-scale process control system characterized by a distributed network of processors and I/O subsystems that encompass the functions of control, user interface, data collection, and system management. DCSs are commonly used in large industrial facilities, such as chemical plants, petroleum refineries, and paper mills.

Distributed Component Object Model (DCOM): Distributed version of Microsoft's COM architecture, allowing applications to be readily integrated across networks.

Drift: A change in an instrument's reading or setpoint value over extended periods due to factors such as time, line voltage, or ambient temperature effects.

Driver: Software that controls a specific hardware device such as a PC board or programmable controller.

Dynamic Data Exchange (DDE): Microsoft inter-process communication protocol for transferring data among Microsoft Windows-based applications. Predecessor to OLE.

Dynamic Link Library (DLL): Executable code and data that can be called or used by Microsoft Windows-based applications or other DLLs. Functions and data in a DLL are loaded and linked when referenced.

Dynamic range: Ratio of the largest to smallest signal level a circuit can handle, normally expressed in dB.

E

EEPROM: Electrically erasable programmable ROM; read-only memory that can be erased and reprogrammed.

Electromagnetic interference (EMI): Electrical noise

induced upon signal wires with the possible effect of obscuring the instrument signal.

Electromotive force (EMF): A measure of voltage in an electrical circuit.

Encoder: Device that converts linear or rotary displacement into digital or pulse signals.

EPROM: Erasable programmable ROM; read only memory that can be erased (usually by ultraviolet light exposure) and reprogrammed.

Error: The difference between the correct or desired value and the actual reading or value taken.

Ethernet: Popular local area networking technology used for office applications and, increasingly, control network and data acquisition applications.

External trigger: Voltage pulse from an external source that triggers an event such as A/D conversion.

F

Fiber Distributed Data Interface (FDDI): Standard defining a high capacity, dual-ring fiber optic communication protocol.

Fieldbus: All-digital communication network used to connect process instrumentation and control systems. Designed to replace existing 4-20 mA analog signals with bidirectional, multivariable data communications capability.

Fieldbus Foundation: Austin, Texas-based nonprofit consortium of instrumentation suppliers that is developing a standard digital communication network (fieldbus) for process control applications. The network developed by the Foundation is referred to as the Foundation Fieldbus.

First-in first-out (FIFO): Memory buffer in which the first data stored is the first data sent.

Flash ADC: High-speed ADC whose output code is determined in a single step by a bank of comparators and encoding logic.

Frequency: The number of cycles over a specified time period over which an event occurs. Normally expressed in cycles per second (hertz, Hz).

Function: A set of software instructions executed by a single line of code that may have input and/or output parameters and returns a value when executed.

G

Gain accuracy: Measure of deviation of the gain of an amplifier from the ideal gain.

Gain: The amount of amplification used in an electrical circuit, sometime expressed in decibels, dB.

General Purpose Interface Bus (GPIB): Synonymous

with HP-IB (for Hewlett-Packard), the standard bus used for controlling electronic instruments with a computer. Also called IEEE 488 in reference to defining ANSI/IEEE standards.

Graphical user interface (GUI): An intuitive, graphical means of communicating information between computer-based devices and human users. GUIs can resemble the front panels of instruments or other objects associated with a computer program.

Ground: The electrical neutral line having the same potential as the surrounding earth; the negative side of a direct current power system; the reference point for an electrical system.

H

Hardware: Typically refers to the physical components of a data acquisition system, such as PCs, boards, data conversion devices, etc.

Hertz (Hz): Unit of frequency, defined as one cycle per second.

Hierarchical: Method of organizing computer programs with a series of levels, each with further subdivisions.

Human-machine interface (HMI): The means by which a human operator interacts with an industrial machine or other piece of equipment. See also graphical user interface.

I

IEEE 488: See General Purpose Interface Bus.

Impedance: The total opposition to electrical flow in an electrical circuit.

Input bias current: Current that flows into circuit inputs.

Input impedance: The measured resistance and capacitance between the input terminals of a circuit.

Input offset current: Difference in the input bias currents of the two inputs of an instrumentation amplifier.

Input/output (I/O): The transfer of data to and from a computer system involving communications channels, operator interface devices, and/or data acquisition and control interfaces.

Institute of Electrical and Electronic Engineers (IEEE): Professional and standards-writing organization of electrical and computer-related professionals.

Integral control: Control action that eliminates the offset inherent in proportional control. Offset from setpoint is “integrated” over time resulting in an output correction.

Integral nonlinearity (INL): A measure in LSB of the worst-case deviation from the ideal A/D or D/A transfer

characteristic of analog I/O circuitry.

Integrating ADC: ADC that works by integrating an unknown voltage over time. Time required is compared to the time required to integrate a known reference voltage.

Interchangeability error: A measurement error that can occur if two or more sensors are used to make the same measurement. Caused by slight variations from sensor to sensor.

Interpreter: Software utility that executes source code from a high-level language such as Visual Basic or C by reading one line at a time and executing the specified operation. See also Compiler.

Interrupt: Computer signal indicating that the CPU should suspend its current task to service a designated activity.

Intrinsically safe: An instrument in which electrical energy is limited such that it will not spark or otherwise ignite a flammable mixture.

ISA: Formerly the Instrument Society of America, now referred to as the International Society for Measurement & Control.

Isolation voltage: Voltage an isolated circuit can normally withstand, usually specified from input to input and/or from any input to the amplifier output, or to the computer bus.

J

Joint time-frequency analysis (JTFA): Technique for spectral analysis of rapidly changing waveforms.

L

Linearity: The deviation of an instrument’s response from a straight line.

Local area network (LAN): Network of computer-based devices, typically PCs and associated peripherals in a geographically limited location.

Logical address: Digital number that uniquely identifies each device in a system.

Loop resistance: The total resistance of a complete electrical circuit.

Least significant bit (LSB): Refers to the smallest increment of resolution in an A/D or D/A conversion.

M

Mainframe: Chassis that mechanically contains boards or modules inserted into a backplane. Provides environment conditioning and vibration and shock-resistant connections.

Man-machine interface (MMI): See Human-machine interface.

Media access control (MAC): Networking layer that determines which node can access the physical media.

Million floating-point operations per second (MFLOPS): Unit for expressing the computational power of a processor.

Milliamp (mA): One thousandth of an ampere.

Million instructions per second (MIPS): Unit for expressing the speed of processor execution of machine code instructions.

Millivolt (mV): One thousandth of a volt.

Module: A board assembly and its associated mechanical parts. A module contains everything required to occupy one or more slots in a mainframe chassis.

Multiplexer (Mux): A switching device that sequentially connects multiple inputs or outputs in order to process several signal channels with a single A/D or D/A converter.

Multitasking: Property of an operating system in which several processes can be run simultaneously.

N

Noise: Any undesirable electrical signal, from external sources such as ac power lines, motors, electrical storms, and radio transmitters, as well as internal sources such as electrical components.

Normal-mode rejection ratio: The ability of an instrument to reject electrical interference across its input terminals, normally of line frequency (50-60 Hz).

Nyquist theorem: Law of sampling theory stating that data sampling frequency should be at least twice that of the highest frequency variations in the signal of interest. Must be observed to preserve patterns in data and to not introduce artificial, lower frequency patterns.

O

Object Linking and Embedding (OLE): Set of Microsoft system services that provides a means for application integration. Based on COM technology, OLE allows applications to dynamically identify and use the data and services of other applications.

Objects: Self-contained software modes that encapsulate both data and processing logic.

Ohmmer: A device used to measure electrical resistance.

OLE Control: See ActiveX Control.

Open Systems Interconnect (OSI): A seven-layer model for generically describing modern networking technologies.

Operating system: Base-level software that controls a computer, runs programs, interacts with users, and communicates with installed hardware or peripheral devices.

Optical isolation: Two networks or circuits in which an

LED transmitter and receiver are used to maintain electrical discontinuity between the circuits.

Output settling time: Time required for the analog output voltage to reach its final value within specified limits.

Output slew rate: Maximum rate of change of analog output voltage from one level to another.

Overhead: Amount of computer processing resources required to accomplish a task.

P

Personal Computer Memory Card International Association (PCMCIA): An expansion card form factor popular in laptop and notebook computers.

Peripheral Component Interconnect (PCI): High-performance expansion bus architecture common in modern desktop PCs.

Phase: A time-based relationship between a periodic function and a reference.

Plug and Play ISA: Specification that allows PC ISA boards to be fully configured in software, without jumpers or switches on the boards.

Polarity: In electricity, the quality of having two charged poles, one positive and one negative.

Port: A communications connection on a computer-based device.

Posttriggering: The acquisition of a programmed number of samples by a data acquisition board after trigger conditions are met.

Power supply: A separate unit or part of a circuit that provides power to the rest of a circuit.

Pretriggering: A data acquisition board that maintains a continuous buffer of data, so that when trigger conditions are met, data generated before the condition occurred can be acquired.

Profibus: Family of fieldbus, device-level, and cell controller protocols for industrial automation.

Programmable gain amplifier (PGA): Signal amplifier that can be programmed to apply a different signal gain depending on the input voltage. Effectively increases dynamic range and sensitivity of A/D converter.

Programmable logic controller (PLC): Special-purpose computer used in industrial monitoring and control applications.

Propagation delay: Amount of time required for a signal to pass through a circuit.

Proportional control: Control action in which output corrections are directly proportional to the process variable's deviation from setpoint.

Proportional-integral-derivative (PID) control: Three-term control algorithm combining proportional, integral, and derivative control actions.

Protocol: Defined sequence of bits, characters, and control codes used to transfer data among computer-based devices.

Q

Quantization error: Inherent uncertainty in an A/D conversion due to the finite resolution of the conversion process.

R

Radio frequency interference (RFI): Noise induced upon signal wires by ambient radio-frequency electromagnetic radiation with the effect of obscuring the instrument signal.

Range: An area between two limits within which a quantity is measured, stated in terms of a lower and upper limit.

Relative accuracy: Measure in LSB of the accuracy of an ADC. It includes all non-linearity and quantization errors.

Remote terminal unit: Industrial control and data collection device similar to a PLC, but designed for remote communication via wire-based or radio telemetry.

Repeatability: The ability of an instrument to give the same output or reading under repeated, identical conditions.

Resistance temperature detector (RTD): A metallic probe that measures temperature based upon its coefficient of resistivity.

Resistance: The resistance to the flow of electric current, measured in ohms.

Resolution: The smallest signal increment that can be detected by a measurement system. Resolution can be expressed in bits, in proportions, or in percent of full scale. For example, a system has 12-bit resolution, one part in 4,096 resolution, and 0.0244 percent of full scale.

Ribbon cable: Flat cable in which the conductors are side by side.

Root-mean-square (RMS): Averaging algorithm that results from the square root of the arithmetical mean of the squares.

S

Sample-and-hold (S/H): Circuit that acquires and stores an analog voltage on a capacitor for subsequent conversion.

Self-calibrating: Data acquisition board that calibrates its own A/D and D/A circuits with reference to a stable onboard reference.

Sensitivity: The minimum change in a physical variable to which an instrument can respond.

Sequenced Packet Exchange/Internetwork Packet Exchange (SPE/IPE): Novell implementation of network addressing scheme.

Shielded twisted pair (STP): Cable construction that includes an external grounded shield, as well as twisting on a regular basis to help minimize noise interferences.

Signal-to-noise ratio (SNR): The ratio of the overall rms signal level to the rms noise level, expressed in dB.

Simultaneous sampling (SS): System in which each input or output channel is digitized or updated at the same time.

Single-ended (SE): An analog input that is measured with respect to a common ground.

Software trigger: A programmed event that triggers an event such as data acquisition.

Span: The difference between the upper and lower limits of a range, expressed in the same units as the range.

Stability: The ability of an instrument or sensor to maintain a consistent output when a constant input is applied.

Statistical process control (SPC): Analysis methodology in which characteristics of a process are measured or counted and tracked. Statistical rules are used to determine whether variations are random or need correction.

Strain gauge: Sensor whose resistance varies with applied force.

Structured Query Language (SQL): Computer language used to interact with databases.

Subroutine: Set of software instructions executed by a single line of code that may have input and/or output parameters.

Successive-approximation ADC: ADC that sequentially compares a series of binary-weighted values with an analog input to produce an output digital word in n steps, where n is the bit resolution of the ADC.

Supervisory control and data acquisition (SCADA): Automation and control architecture in which direct control and data acquisition are performed by PLCs and/or RTUs and supervised by another computer-based device, often a PC.

Synchronous: An event or action that is synchronized to a reference clock.

System noise: Measure of the amount of noise seen by an analog circuit or an ADC when the analog inputs are grounded.

T

Thermistor: A semiconductor sensor that exhibits a repeatable change in electrical resistance as a function of temperature. Most thermistors exhibit a negative temperature coefficient.

Thermocouple: The junction of two dissimilar metals through which a measurable current flows depending on the temperature difference between the two junctions.

Throughput rate: Speed of execution, in samples or bits per second, for a given continuous operation, calculated to include software overhead.

Transfer rate: Rate at which data is moved from source to destination.

Transistor-to-transistor logic (TTL): Voltage-level changes readily communicated and interpreted by microprocessors, typically in the 0-5 V range.

Transmission Control Protocol/Internet Protocol (TCP/IP): A set of standard protocols for communicating across a single network or interconnected set of networks.

U

Unipolar: A signal range that is always positive (for

example, 1 to 5 V).

Unshielded twisted pair (UTP): Cable construction consisting of pairs of wires twisted at regular intervals (called the pitch) in order to reduce electrical noise interferences.

V

Volt (V): The electrical potential difference between two points in a circuit. One volt is the potential needed to move one coulomb of charge between two points while using one joule of energy.

W

Wide area network (WAN): Computer network typically designed to include and embrace multiple local area networks across multiple geographic locations.

Word: Standard number of bits that a processor or memory manipulates at one time. Microprocessors typically use 8, 16, or 32-bit words.

Z

Zero offset: The non-zero output of an instrument, expressed in units of measure, under conditions of true zero.

Index

A		Data acquisition systems,	
Acronyms (table)	3	boards/cards	38
ActiveX Controls	51	hardware	36
Alarm modules	44	high accuracy	39
Aliasing	10	high speed	38
Amplifiers,		rack-mount	42
function	14	selection criteria	36
programmable gain (PGA)	14	software	48
Analog-to-digital conversion (ADC),		specialty boards	40
accuracy	12	Data communication equipment (DCE)	25
acquisition time	12	Data terminal equipment (DTE)	25
conversion time	12	Data Link Layer (DLL)	35
definition	10	Data loggers	63
selection factors	11	Decimal prefixes	2
throughput	12	Differential inputs	17
transfer time	12	Digital input/output	
types	12-13	(see Input/output)	
Application-specific integrated circuits (ASICs)	37	Digital-to-analog (D/A) conversion	10, 15
ARCnet	28	DIN rail	43
Auto dialers	47	Distributed Component Object Model (DCOM)	51
B		Dynamic Data Exchange (DDE)	33
Backbones	32	E	
Backplanes	43	EIA-485	26
Burst mode sampling	14	Electrical,	
Bus topologies	28	relationships	19
C		symbols	2
C++	50	units	19
Cabling,		Electrical Industries Association	26
(also see Wiring)		Ethernet	28
analog options	22	Excitation	14
coaxial	23	F	
digital network	27	Fiber Distributed Data Interface (FDDI)	32
Carrier Sense Multiple Access with Collision Detection (CSMA/CD)	29	Fiber optics,	
Code width	39	multi-mode	27
Cold junction compensation (CJC)	44	single mode	27
Compact PCI	41	Fieldbus networks	34
Comparators	13	Filtering	11, 14
Component Object Model (COM)	51	Flash/parallel ADCs	12
Contact closure	18	Foundation fieldbus	34
Current-to-voltage conversion	14	Fourier, Jean Baptiste Joseph	19
D		G	
Data acquisition,		Gain	14
definition	10	Gateways	31
		General Purpose Interface Bus (GPIB)	26

Ground loops	22	Noise,	
Grounding	20	frequencies	20
H		sources	20
Hypertext Markup Language (HTML)	33	Nyquist theorem	11
I		0	
IEEE-488	27	Object Linking & Embedding (OLE)	51
Industry Standard Architecture (ISA)	41	Object orientation	51
Input/output,		Ohm, George Simon	19
analog outputs	15	Omega Engineering,	
differential analog	15	about	8
digital inputs	17	contact information	68
digital outputs	18	Open Systems Interconnect (OSI)	24
general	10	Operating systems	48
hardware	36	Oscilloscopes,	
pulse	18	analog	64
remote	45	digital storage (DSO)	64
selection criteria	37	features	65
single-ended analog	15	recorders	64
Integrating ADCs	12	selection criteria	65
Isolation	15	P	
J		PC bus architectures	
Java	33	capacities	42
Jitter	28	descriptions	41
M		speed comparisons	42
Media Access Control (MAC)	25	PC/104	41
Metropolitan area networks (MANs)	32	Peripheral Component Interconnect (PCI)	41
Micro Channel Architecture (MCA)	41	Personal Computer Memory Card	
Modems,		International Association (PCMCIA)	41
fiber optic	46	Profibus	33
high-speed	46	Programmable gain amplifier (PGA)	14
isolated	45	Protocol converters	46
limited distance	45	Q	
Multiplexing	14	Quantization error	10
N		R	
Networking/networks,		Ramping/counter ADCs	12
concepts	24	Recorders,	
device level	32	circular chart	62
fiber optic	27	classifications	59
fieldbus	32	flatbed	61
media options	25, 29	hybrid	60
models	24	oscillographic	64
parallel	27	selection criteria	64
routing	32	strip-chart	60
selection criteria	24	trend	60
serial	26	videographic	66
shielding	27	XY	62
topologies	28	Relay, driving	18
wireless	30, 46	Resistor,	

color codes	2	mathematical manipulation	55
networks	16	operating systems	50
standard values	2	selection procedure	53
Resolution	10, 37	statistical analysis	56
Ring topology	28	Statistical process/quality control (SPC/SQC)	56
RS-232	25	Successive approximation ADCs	13
RS-422	26	T	
RS-485	25	Temperature input boards	40
S		ThinNet	29
Sample-and-hold (SH) circuitry,		Token networks	28
concept	14	Transistor-to-transistor logic (TTL)	10
functionality	41	Transmission Control Protocol/Internet Protocol (TCP/IP)	31
Sample rate	10, 37	Transmitters	44
Satellite applications	32	Triggering	18
Sensitivity	11	U	
Sensor,		Universal Serial Bus (USB)	41
input boards	40	V	
types	20, 40	Video Electronics Standards Association (VESA)	41
Sequenced Packet Exchange/Internetwork Packet Exchange (SPX/IPX)	31	VMEbus	43
Settling time	16	VXIbus	43
Signal,		W	
scaling	14	Waveform	19
types	19	Wide area networks (WANs)	32
typical ranges	10, 37	Wireless networks,	
Signal conditioning,		cellular/trunked	46
functions	11, 36	Ethernet	30
hardware	44	licensed radio frequency	46
Signal-to-noise ratio	21	microwave	46
Simultaneous sampling	14	spread spectrum	46
Single-ended inputs	15	unlicensed	46
Star topology	28	Wiring,	
Software,		(also see Cabling)	
components	50	grades	27
curve-fitting	55	plain pair	22
data interface	57	unshielded twisted pair (UTP)	23, 27
development	48	shielded twisted pair (STP)	23, 27
process monitoring	54	shielding	27

List of Figures

Section 1 Analog I/O Functionality		3-6. Correct Grounding of Signal Circuit	21
1-1. Functional Diagram for Data Acquisition	10	3-7. Coaxial Cable Construction	22
1-2. The Analog-to-Digital Interface	10	Section 4 Digital Signal Transmissions	
1-3. A/D Conversion Compromises	11	4-1. The Seven-Layer OSI Network Model	24
1-4. Aliasing Due to Slow Sample Rate	11	4-2. Serial Data Transmission	25
1-5. Analog Input Flow Diagram	11	4-3. Cable Length vs. RS 422 Data Rate	26
1-6. Alternative A/D Converter Designs	12	4-4. Shielded Twisted Pair (STP) Construction	27
1-7. A/D Conversion by Successive Approximation	12	4-5. Ring Network Topology	28
1-8. A/D Conversion by Flash/Parallel Technique	13	4-6. Bus Network Topology	29
1-9. A/D Conversion by Counting/Ramp Technique	13	4-7. Star Network Topology	29
1-10. Alternative Methods for Eliminating Time Skew Among Multiplexed Channels	14	4-8. A Remote File Request According to OSI	30
1-11. Conversion of 4-20 mA to 1-5 V	14	4-9. Dual-Ring Redundant FDDI Network	30
1-12. Single-Ended & Differential Analog Input Configurations	15	4-10. Profibus Applications	31
1-13. Weighted Value & Single Value Resistor Networks for D/A Conversion	15	4-11. Protocol Architecture of Profibus	32
Section 2 Digital I/O Functionality		4-12. Foundation Fieldbus Protocol	33
2-1. Signal Processing Requirements for Digital and Analog Signals	17	4-13. Typical Enterprise Network	34
2-2. Digital Input Applied to a Contact Closure	17	Section 5 Data Acquisition Hardware	
2-3. Digital Output Applied to a Relay	18	5-1. Computer Bus Architecture	42
Section 3 Analog Signal Transmissions		Section 6 Presentation & Analysis	
3-1. A Basic Electric Current	19	6-1. Cost of Writing vs. Buying Software	49
3-2. Digital and Analog Signal Representations	19	6-2. Advantages of Component Software	50
3-3. Signal, Noise, and Filtering Frequencies	20	6-3. Semi-Custom Development vs. Off-the-Shelf Packages	52
3-4. A Ground Conductor	20	6-4. Primary Data Analysis Techniques	55
3-5. Incorrect Grounding of Signal Circuit	21	Section 7 Recording, Printing & Storage	
		7-1. Typical Strip-Chart Recorder Trace	58
		7-2. Typical Circular Chart Recorder Trace	60

Complete Reverse Side to
Receive Your Own



Dilbert Card Decks

OMEGA ENGINEERING, INC.
ONE OMEGA DRIVE
P.O. BOX 4047
STAMFORD CT 06907-0047

PLACE
STAMP
HERE

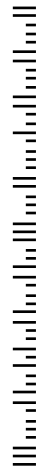
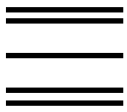

Complete Reverse Side to
Receive Your Own



Giant Poster Bulletins!

OMEGA ENGINEERING, INC.
ONE OMEGA DRIVE
P.O. BOX 4047
STAMFORD CT 06907-0047

PLACE
STAMP
HERE

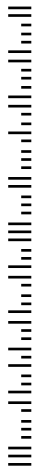
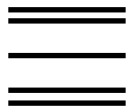

Complete Reverse Side to
Receive Your Own



Hardcover Handbooks

OMEGA ENGINEERING, INC.
ONE OMEGA DRIVE
P.O. BOX 4047
STAMFORD CT 06907-0047

PLACE
STAMP
HERE

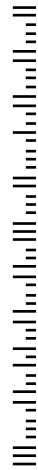
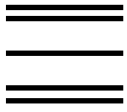

Complete Reverse Side to
Receive Your Own



Transactions of Measurement & Control

OMEGA ENGINEERING, INC.
ONE OMEGA DRIVE
P.O. BOX 4047
STAMFORD CT 06907-0047

PLACE
STAMP
HERE





YES!

Send Me the Following
BRAND NEW!, **FREE!**
OMEGA® Handbooks!

- Purchasing Agent Edition
- Temperature and Humidity
- Pressure, Strain, and Force
- Flow and Level
- pH and Conductivity
- Data Acquisition Handbook
- Universal Guide to
- Data Acquisition
- Electric Heaters
- The Green Book®
- 21st Century™ Preview Edition
- Book of Books® Update
- Transactions

From our affiliate companies

- OMEGADYNE™ Pressure
- Force Load Torque Database
- NEWPORT™ Volume V Database

YES!

Send Me the Following
BRAND NEW!, **FREE!**
OMEGA® Transactions of
Measurement and Control:

- Infrared Temperature Measurement and Control (1Q98)
- Data Acquisition in Process Control (2Q98)
- Pressure, Force, and Load Measurement and Control (3Q98)
- Measurement and Control of Environmental Parameters (4Q98)

Already sent for your OMEGA® Transactions of Measurement and Control? Pass this card on. Your colleague will thank you.

©COPYRIGHT 1988 OMEGA ENGINEERING, INC. ALL RIGHTS RESERVED.

Fill out card completely. Please print information clearly:

Name _____

Corporate e-mail: _____

Personal e-mail: _____

Title _____

Company _____

Company Address _____

City _____ State _____ Zip _____

Phone # _____ Fax # _____

Street Address _____

City _____ State _____ Zip _____

1. What is the principal activity at this location?
 Manufacturing Service R&D

2. What is the PRIMARY end product manufactured or service performed at your business location? (Please be specific): _____

3. What is the approximate number of employees at this location?
 1-19 20-49 50-99 100-499 500-999 1000+

Already sent for your OMEGA® Handbooks? Pass this card on. Your colleague will thank you.

©COPYRIGHT 1988 OMEGA ENGINEERING, INC. ALL RIGHTS RESERVED.

Fill out card completely. Please print information clearly:

Name _____

Corporate e-mail: _____

Personal e-mail: _____

Title _____

Company _____

Company Address _____

City _____ State _____ Zip _____

Phone # _____ Fax # _____

Street Address _____

City _____ State _____ Zip _____

1. What is the principal activity at this location?
 Manufacturing Service R&D

2. What is the PRIMARY end product manufactured or service performed at your business location? (Please be specific): _____

3. What is the approximate number of employees at this location?
 1-19 20-49 50-99 100-499 500-999 1000+

YES!

Send Me the BRAND NEW!,
FREE! Dilbert Deck Cards!

- Dilbert Deck Cards



Already sent for your Dilbert Deck Cards? Pass this card on. Your colleague will thank you.

©COPYRIGHT 1988 OMEGA ENGINEERING, INC. ALL RIGHTS RESERVED.

Dilbert © United Feature Syndicate, Inc.

YES!

Send Me the Following
BRAND NEW!, **FREE!**
OMEGA® Giant Posters:

- Space Shuttle Patches
- Rockets of the World
- Chart of Dimensionless Numbers
- Radio Frequencies
- Dilbert Deck

Already sent for your OMEGA® Giant Poster Bulletins? Pass this card on. Your colleague will thank you.

©COPYRIGHT 1988 OMEGA ENGINEERING, INC. ALL RIGHTS RESERVED.

Fill out card completely. Please print information clearly:

Name _____

Corporate e-mail: _____

Personal e-mail: _____

Title _____

Company _____

Company Address _____

City _____ State _____ Zip _____

Phone # _____ Fax # _____

Street Address _____

City _____ State _____ Zip _____

1. What is the principal activity at this location?
 Manufacturing Service R&D

2. What is the PRIMARY end product manufactured or service performed at your business location? (Please be specific): _____

3. What is the approximate number of employees at this location?
 1-19 20-49 50-99 100-499 500-999 1000+

Fill out card completely. Please print information clearly:

Name _____

Corporate e-mail: _____

Personal e-mail: _____

Title _____

Company _____

Company Address _____

City _____ State _____ Zip _____

Phone # _____ Fax # _____

Street Address _____

City _____ State _____ Zip _____

1. What is the principal activity at this location?
 Manufacturing Service R&D

2. What is the PRIMARY end product manufactured or service performed at your business location? (Please be specific): _____

3. What is the approximate number of employees at this location?
 1-19 20-49 50-99 100-499 500-999 1000+



©1998 Putman Publishing Company and OMEGA Press LLC.